

A DESIGN TOOL FOR THE EVALUATION OF ATMOSPHERE
INDEPENDENT PROPULSION IN SUBMARINES

by

Grant B. Thornton, LCDR, USN

B.S., Marine Engineering
United States Naval Academy, 1979

SUBMITTED TO THE DEPARTMENTS OF OCEAN ENGINEERING
AND MECHANICAL ENGINEERING IN PARTIAL FULFILMENT
OF THE REQUIREMENTS FOR THE DEGREES OF
MASTER OF SCIENCE IN NAVAL ARCHITECTURE AND MARINE ENGINEERING

and

MASTER OF SCIENCE IN MECHANICAL ENGINEERING

at the

MASSACHUSETTS INSTITUTE OF TECHNOLOGY

May 1994

Copyright © 1994 Grant B. Thornton

The author hereby grants to MIT permission to reproduce and to distribute
publicly paper and electronic copies of this thesis document in whole or in part.

Signature of Author Grant B. Thornton
Departments of Ocean and Mechanical Engineering
May 6, 1994

Certified by _____
Professor David Gordon Wilson
Thesis Reader
Department of Mechanical Engineering

Accepted by _____
Professor A. Douglas Carmichael
Thesis Advisor and
Chairman, Department Committee on Graduate Students
Department of Ocean Engineering

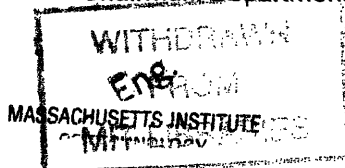

JUN 20 1994

LIBRARIES

(Blank Reverse)

A DESIGN TOOL FOR THE EVALUATION OF ATMOSPHERE
INDEPENDENT PROPULSION IN SUBMARINES

by

Grant Blount Thornton

Submitted to the Departments of Ocean Engineering and Mechanical Engineering on May 6, 1994 in partial fulfillment of the requirements for the Degrees of Master of Science in Naval Architecture and Marine Engineering and Master of Science in Mechanical Engineering.

ABSTRACT

For the United States Navy, submarine propulsion has long since evolved from Diesel Electric to a complete reliance on Nuclear Power. Nuclear propulsion is the ultimate atmosphere independent power source, allowing the submarine to divorce itself from the surface, limited only by the endurance of the crew embarked.

Submarine construction and operating costs have grown dramatically, due largely to the cost of the high performance nuclear propulsion plant. Other options exist to provide Atmosphere Independent Propulsion of similar capability for extended underwater periods at a potentially lower cost.

This thesis explores the aspects of non-nuclear atmosphere independent propulsion as an integral part of the submarine design process, focusing on methods for power generation and various options for fuel and oxidant storage.

Fuel sources include pure hydrogen, stored cryogenically or in metal hydrides, or more common fuels such as diesel or methanol, used either directly or in a reformed state. Oxidants include pure oxygen, stored cryogenically or in compressed form, as well as hydrogen peroxide and sodium perchlorate. Energy conversion methods examined include mechanical such as closed cycle diesels, Brayton cycles and Stirling engines, to electro-chemical designs, such as fuel cells and aluminum oxygen semi-cells.

A computer code was written which integrates these propulsion options with mission and owner's requirements to provide a balanced design in terms of matching the weights and volumes of the equipment installed. This code will serve as a tool for the concept design of non-nuclear air independent submarines.

Thesis Supervisor: A. Douglas Carmichael, Professor of Ocean Engineering

Thesis Reader: David Gordon Wilson, Professor of Mechanical Engineering

(Blank Reverse)

ACKNOWLEDGEMENTS

I wish to acknowledge the following persons who aided me in my search for reference material:

Dave Bagley	NSWC Annapolis
Mark Cervi	NSWC Annapolis
Henry DeRonck	International Fuel Cells
LCDR Norbert Doerry	NAVSEA
Richard Martin	Draper Laboratory
Warren Reid	NSWC Annapolis
Ed Robinson	NAVSEA PEO SUB-R
Steve Sinsabaugh	LORAL Defense Industries
LT Cliff Whitcomb	NSWC Carderock

I hope that I have correctly interpreted the information that you made available to me.

I am grateful for the counsel in ship and submarine design provided by Professors Alan Brown and Jeff Reed in the Naval Construction and Engineering Program at MIT.

I wish to thank my Thesis Advisor, Professor A. D. Carmichael who inspired me to investigate the realm of Air Independent Propulsion as a student, who stood by me as I worked to put my research together in an orderly fashion, and who taught me to be aware of the salesman and the customer when evaluating data.

But most of all, I am thankful for the love and understanding of my family; Daryl, David and Megan, as I complete my studies at MIT.

(Blank Reverse)

TABLE OF CONTENTS

ABSTRACT	3
ACKNOWLEDGEMENTS	5
TABLE OF CONTENTS	7
LIST OF FIGURES	13
LIST OF TABLES	17
CHAPTER ONE	
1.0 Introduction	19
1.1 History	19
1.2 Air Independence Concept	20
1.3 Propulsion Options	21
1.4 Thesis Objective	21
CHAPTER TWO	
2.0 The Design Process	25
2.1 Mission Requirements	27
2.2 Required Operational Capabilities	29
2.3 Submarine Hull Synthesis	33
CHAPTER THREE	
3.0 Submarine Systems	37
3.1 Propulsion Integration	38
3.1.1 Conventional DC	38
3.1.2 Permanent Magnet AC	40
3.1.3 Superconducting Homopolar DC	42
3.1.4 Propulsors	44
3.2 Ship Service Power Requirements	44
3.3 Auxiliary Systems	46
3.4 Atmosphere Control	46
CHAPTER FOUR	
4.0 Power Sources	51
4.1 Electro-Chemical Concepts	52
4.1.1 Fuel Cells	52
4.1.1.1 Proton Exch. Membrane Fuel Cells	54
4.1.1.2 Alkaline Fuel Cells	57
4.1.1.3 Phosphoric Acid Fuel Cells	57
4.1.1.4 Molten Carbonate Fuel Cell	58
4.1.1.5 Solid Oxide Fuel Cell	60
4.1.1.6 Direct Methanol Oxidation Fuel Cell	60
4.1.2 Aluminum Oxygen Semi-Cell	62
4.1.3 Batteries	64
4.1.3.1 Lead Acid Batteries	65
4.1.3.2 Nickel-Cadmium Batteries	68

(Blank Reverse)

4.1.3.3	Silver-Zinc	.70
4.1.3.4	Lithium-Aluminum / Iron Sulfide	72
4.2	Mechanical Power Sources	74
4.2.1	Closed Cycle Engines	74
4.2.1.1	Closed Cycle Diesel	74
4.2.1.2	Closed Brayton Cycle	77
4.2.2	Stirling Engine	79
4.2.3	Other Power Cycles	80
4.2.3.1	Rankine Cycle	81
4.2.3.2	Small Nuclear Power	83
4.2.3.3	Walter Cycle	83
CHAPTER FIVE		
5.0	Reactants	87
5.1	Fuels	88
5.1.1	Hydrogen	88
5.1.1.1	Hydrogen - Gaseous Storage	89
5.1.1.2	Hydrogen - Cryogenic Storage	89
5.1.1.3	Hydrogen - Metal Hydride	90
5.1.1.4	Hydrogen - By Reformation	92
5.1.2	Other Fuels	94
5.2	Oxidants	95
5.2.1	Oxygen	95
5.2.1.1	Oxygen - Gaseous Storage	95
5.2.1.2	Oxygen - Cryogenic Storage	96
5.2.1.3	Oxygen - Chemical Reformation	98
5.2.1.4	Oxygen - Generation Onboard	99
5.2.2	High Test Hydrogen Peroxide	99
5.3	Waste Products	101
CHAPTER SIX		
6.0	The Submarine Model	105
6.1	Hull Envelope	106
6.2	Volume Estimates	107
6.2.1	Pressure Hull Volume	107
6.2.1.1	Mobility Volume	107
6.2.1.2	Weapons and C3I Volume	108
6.2.1.3	Ship Support Volume	108
6.2.2	Other Volumes	109
6.3	Weight Estimates	110
6.3.1	Surfaced Displacement	111
6.3.1.1	Structural Weight	111
6.3.1.2	Mobility Weight	111
6.3.1.3	Weapons and C3I Weight	112
6.3.1.4	Ship Support Weight	112
6.3.1.5	Fixed Ballast and Variable Load Wt	113

(Blank Reverse)

6.4	Powering and Edurance	114
6.4.1	Powering	114
6.4.1.1	Hydrodynamics	114
6.4.1.2	Propulsion Motor Turndown	117
6.4.2	Snort Power and Bunker Fuel Calculation	117
6.4.3	Hotel Loads	118
6.4.4	Battery Endurance	119
6.5	The AIP Plant	120
CHAPTER SEVEN		
7.0	Computer Code Development	121
7.1	Overview	121
CHAPTER EIGHT		
8.0	Results and Conclusions	125
8.1	Model Validation	125
8.2	General Results	127
8.2.1	Overall AIP Impact	128
8.2.2	Impact of Reactants	130
8.2.3	Impact of Other Technologies	132
8.3	Ship Trade-offs.	135
CHAPTER NINE		
9.0	Areas for Future Study	139
REFERENCES		141
APPENDIX A - POWER SOURCE DOCUMENTATION		147
APPENDIX B - REACTANT DOCUMENTATION		163
APPENDIX C - BASELINE MODEL		175
APPENDIX D - HULL ENVELOPE		191
APPENDIX E - VOLUME DATA BASE		195
APPENDIX F - WEIGHT DATA BASE		201
APPENDIX G - SNORKEL POWERING		205
APPENDIX H - RESULT DATA TABLES.		207
APPENDIX I - COMPUTER CODE		211

(Blank Reverse)

LIST OF FIGURES

2.1	Acquisition Milestones and Phases	26
2.2	The Design Spiral	27
2.3	Balancing Weights and Volumes	35
3.1	Battery Stepping Operating Modes for a Double Armature DC Mtr	39
3.2	Permanent Magnet Axial Gap Propulsion Motor	40
3.3	Permanent Magnet High Speed Generator	41
3.4	Example of Chopped AC Output from Input DC	42
3.5	Superconducting Homopolar DC Motor	43
3.6	Typical Ship Service Distribution System	45
3.7	Hydraulic System with Typical Loads	47
3.8	High Pressure Air System	47
3.9	Ventilation Arrangement	49
4.1	Efficiency vs. Load for AIP Options	53
4.2	Proton Exchange Membrane Fuel Cell	55
4.3	PEM Cell Voltage vs. Cell Load	56
4.4	Molten Carbonate Fuel Cell	59
4.5	Westinghouse Solid Oxide Fuel Cell	61
4.6	Aluminum Oxygen Semi-Cell	63
4.7	Lead Acid Battery Schematic	67
4.8	Typical Lead Acid Discharge Characteristics	67
4.9	Nickel-Cadmium Discharge Characteristics	70
4.10	Silver Zinc Discharge Characteristics	72
4.11	LAIS Battery Discharge Characteristics	74
4.12	Closed Cycle Diesel with Exhaust Management System	76
4.13	Closed Brayton Cycle Combustion Power System	78
4.14	Closed Brayton Cycle Schematic Flow Diagram	79
4.15	Stirling Operating Cycle	81
4.16	MESMA Operating Cycle	82
4.17	AMPS Power Cycle	84
4.18	Walter Power Cycle.	85
5.1	Metal Hydride Storage in Ex-U1 (German Type 205)	91
5.2	Hydrogen Content of Various Fuels	94
5.3	Torroidal Gaseous Oxygen Storage Concept	96
5.4	44 Inch UUV Oxygen Supply Concept	98
5.5	Comparison of Oxidant Storage Methods	100
5.6	Liquid / Gas Flow Mixer	102
5.7	Cosworth Exhaust Management System	103
6.1	The Submarine Envelope	106
7.1	"SUBSIZE" Flowchart	122

(Blank Reverse)

8.1	Comparison of Canadian Hybrid Submarine and SUBSIZE Results	126
8.2	Comparison of AIP Plants	129
8.3	AIP Plant Variation with Endurance	129
8.4	Comparison of Oxidant Storage Methods	131
8.5	Comparison of Hydrogen Storage Methods	131
8.6	Comparison of Battery Options with Fixed Creep Endur. Req'm't	132
8.7	Comparison of Battery Options with Fixed Burst Endur. Req'm't	133
8.8	Effect of Propulsive Coefficient on NSC	134
8.9	Effect of L/D Ratio on NSC and SHP	135
8.10	Effect of AIP Speed on NSC	136
A.1	Ni/Cd vs. Discharge Rate	160
B.1	Liquid Oxygen Tank Arrangement	167
C.1	Profile View of Baseline Submarine	176
C.2	Chart of Propeller Efficiency	178
D.1	The Body of Revolution Hull	192
D.2	Effects of n_a and n_r on Hull Geometry	193
E.1	Mobility Density	197
E.2	Torpedo Tube and Reload Density	197
G.1	Wave Drag Coefficient	206

(Blank Reverse)

LIST OF TABLES

1.1	AIP Power Source and Reactant Options	22
2.1	Comparison of AIP/Conventional Submarines	30
2.2	Statement of Requirements	32
2.3	Design Philosophy	33
3.1	Propulsion Options	38
4.1	Electro-Chemical AIP Concepts	52
4.2	Summary of Battery Types	65
4.3	Mechanical AIP Concepts	75
5.1	AIP Reactant Options	87
8.1	Comparison of AIP Plant Densities	127
8.2	Effect of Propulsion Motor Type on NSC	134
8.3	Indiscretion Ratio and Speed of Advance	137
A.1	Summary of Energy Conversion Devices	148
B.1	Reactant Packing Factors	164
C.1	Baseline Submarine Summary	177
C.2	Summary of Propeller Characteristics	177
C.3	Propeller Selection Spreadsheet	179
D.1	Selected Values for C_p and C_{sf}	193
E.1	Summary of Volume Data	196
F.1	Summary of Weight Data	202

(Blank Reverse)

CHAPTER ONE

1.0 INTRODUCTION

1.1 HISTORY

The submarine, a dramatic addition to any country's naval arsenal, is well documented throughout history. With modest beginnings as early as the Turtle in the Revolutionary War [11], the importance of the submarine has grown as technology has enabled the ship to develop greater agility and endurance in its operations. Submersible boats, powered by diesel electric propulsion plants on the surface and lead acid storage batteries submerged, were first used extensively in combat during World War I by the German Navy where they were very effective in sinking considerable military and civilian shipping in an attempt to isolate England and her allies from the United States.

World War II brought more advanced ships into combat with similar tactics as these ships were still not true submersibles. With a hull design more akin to performance on the surface, these were still ships that operated largely on the surface of the sea, only to submerge for their torpedo attack. Though the Germans worked feverishly on developing new technologies to enable the submarine to stay submerged longer, such as the snorkel and an air independent power plant: the Walter Cycle, a carbon dioxide-steam Rankine cycle powered by high test hydrogen peroxide [46], they were eventually overcome by Allied tactics and superior strength. The United States submarine force was also successful in their campaigns against the Japanese Empire. Instrumental in holding the Japanese in check while the United States recovered from the attack on Pearl Harbor, their heroic actions against military and merchant shipping were critical to defeating the Japanese. Still the submarine

was a "surface ship" that dived to attack, and was limited in its ability to obtain air from above to sustain propulsion beyond slow speeds on battery power.

The advent of nuclear power in the late 1950's brought a significant shift in submarine design and use. With a power source that was truly divorced from the surface, an emphasis was placed on underwater performance. Submarine hull shapes similar to the now familiar tear drop "Albacore Hull" became commonplace and tactics, sensors and weapons evolved that were designed to be employed with the ship underwater. The price of nuclear power however is not cheap. Not only was the cost of development expensive, but the necessary infrastructure to build, maintain and train such a force limited its acceptance to only a few nations with the necessary financial resources. This meant that those countries that wished to continue to develop their own submarine fleets must work on improving the "diesel boat" design.

1.2 AIR INDEPENDENCE CONCEPT

While submarine improvements can take many forms, this thesis will concentrate on those which enhance propulsion endurance.

The concept of Air Independent Propulsion (AIP) can be defined many ways, but will be taken here to mean propulsive power that is generated without inducting an oxidant, air, from the atmosphere. Modern diesel electric submarines seek to improve the amount of time that they can divorce from the surface, which is accomplished by increasing the storage capacity of installed secondary batteries and by decreasing the required submerged electrical load through more power efficient equipment and reduced electric propulsion loads (more efficient hull designs and propulsors). Modern diesel electric submarines extend this time to many hours but usually at the expense of limiting the submarine to slow speed and impacting the habitability of the crew. It is the AIP

concept that may enhance the performance of this capable diesel submarine platform by extending this submerged endurance to many weeks, without severely hampering the ship or the crew.

1.3 PROPULSION OPTIONS

Imagine any way to store any form of energy and to convert that stored energy to electricity or mechanical work and you have a potential AIP source. These ideas however must be tempered by common sense and the bounds of what could conceivably be placed in the hull of a submarine. Table 1.1 presents a list of possible AIP power systems that have been proposed or developed, divided into two areas: Power Sources and Reactants. All power sources must consume some combination of reactants, usually a fuel and an oxidant to provide power output. While nuclear power is considered the ultimate AIP source due to its infinite (relative to any mission requirement) stored energy capacity, only non-nuclear AIP sources will be considered in this thesis.

1.4 THESIS OBJECTIVE

Many nations desire the goal of unrestricted submarine operations, but are unable or unwilling to make the step to nuclear power. Even the United States, a world leader in safe and reliable nuclear propulsion may have cause to consider returning to a mix of nuclear and non-nuclear submarines to perform its assigned missions world-wide. The question becomes which one of the possible AIP systems to choose and what will its impact be?

This thesis attempts to answer that question by development of a computer model in "C++" to integrate the submarine design process with the various propulsion plant options and reactant storage methods,

Table 1.1
AIP Power Source and Reactant Options

Power Sources (Electro-Chemical)	Remarks
Proton Exchange Membrane Fuel Cell	Most promising H ₂ -O ₂ cell
Alkaline Fuel Cell	Proven design
Phosphoric Acid Cell	Proven design, low interest
Molten Carbonate Fuel Cell	Mature commercial applications
Solid Oxide Fuel Cell	Immature, highest projected efficiency
Aluminum Oxygen Semi-Cell	Competitive with PEM cell
Lead Acid Battery	Proven performance
Nickel Cadmium Battery	Higher power density than lead acid
Lithium-Aluminum/Iron Sulfide Battery	Potential successor to lead acid
Power Sources (Mechanical)	
Closed Cycle Diesel	Mature, lowest cost system
Stirling Engines	Mature, low power only
Closed Brayton Cycles	Excellent potential for development
Rankine Cycles	Proven technology
Walter Cycles	Safety of H ₂ O ₂
Reactants (Fuel)	
Hydrogen	Pure source, "hard to store"
Hydrocarbon Based Fuels	With reformer-"best" hydrogen source
Reactants (Oxidants)	
Oxygen	Cryogenics best method
Hydrogen Peroxide	Potentially unstable if concentrated
Chemical Reformation	Competitive in some applications

including consideration of owners requirements for ship performance. The model will allow a user to input various performance criteria such as range, maximum speed, AIP endurance, select a type of AIP power plant and form of reactant, and develop a balanced estimate of the required submarine size, in terms of its principal dimensions as well as other submarine attributes such as displacement, reserve buoyancy and lead margins. For the propulsion plant and reactant options, the field was limited to those options which are currently in development or which have had development work attempted, although other options are mentioned.

(Blank Reverse)

CHAPTER TWO

2.0 THE DESIGN PROCESS

The ship procurement process is long and complex, employing many different strategies and methods to achieve a final product that meets the needs of the customer in terms of performance and cost. While there are as many different ways to approach this problem as there are countries that attempt it, they all share a common approach in that they:

- Identify requirements which result in a need for a ship
- Determine required capabilities
- Examine alternatives on paper
- Trade-off these alternatives using self imposed priorities
- Select a concept on which to do detailed design
- Construct the ship and measure its performance
- Evaluate the ship's success in terms of meeting stated requirements

The United States Navy has adopted the format illustrated in Figure 2.1 for this acquisition process. Each milestone represents a decision point where the work from the previous phase is evaluated, and if appropriate a decision made to proceed, with requirements established for the next phase. Each phase represents a process where options are evaluated, and trade-off decisions made to achieve the required level of detail for that design. This thesis supports "Phase 0", the concept design phase of the design process.

Given the operational requirements set out by the owner, concepts to meet these requirements are explored, then for the most viable concepts, estimates are made of the required volume and weight for a ship meeting these

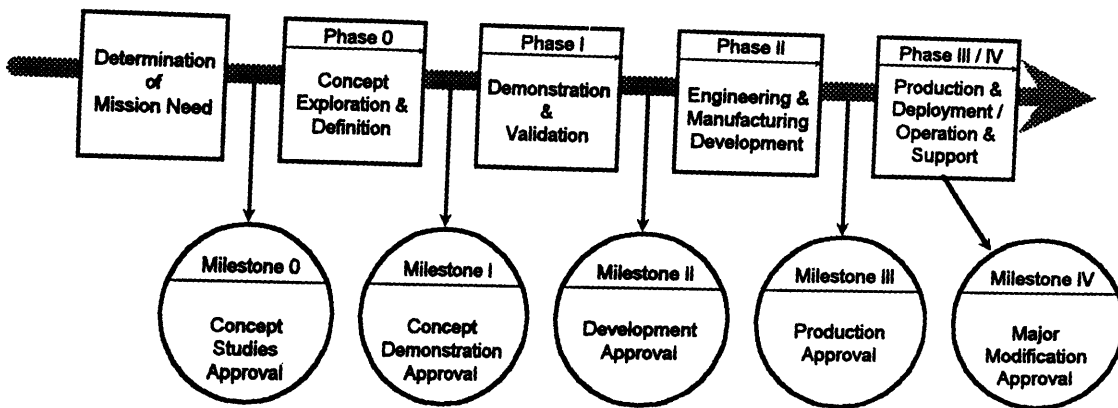

Acquisition Milestones and Phases

Figure 2.1 [9]

requirements and a ship is synthesized, including the buoyancy and balance requirements unique to submarine design. This balancing process is iterative and can be best visualized as a spiral, Figure 2.2. Because a successful design is the result of the efforts of many individual expert teams, each will focus on the current set of requirements, evaluating their impact on each other once all have completed their calculations. From these results, revised requirements are established and each team refines their estimates, each time obtaining a solution more in harmony with the others.

Section 2.1 describes the mission requirements for AIP submarines, one of the key inputs to the development of a concept design. Section 2.2 addresses the process of establishing priorities among the required capabilities established, while Section 2.3 provides an overview of the process required for submarine hull synthesis.

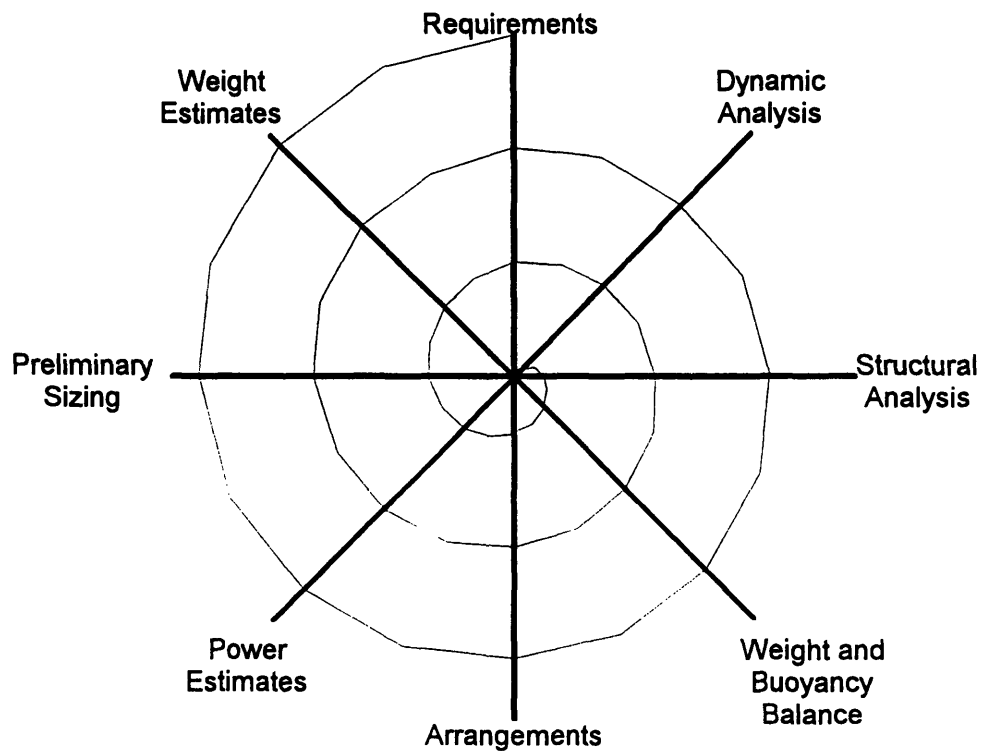

The Design Spiral [34]

Figure 2.2

2.1 MISSION REQUIREMENTS

What performance characteristics should an AIP submarine possess? Clearly the evolution from diesel to nuclear power brought an increase in the ability of the submarine to transit from station to station quickly and covertly, remaining submerged for weeks on end. Aside from this step increase in performance, other improvements in hull and propulsor design have stretched the envelope even further. How many of these and other improvements can be applied to AIP submarine design, and what can the expected performance results be? It will be shown that while an AIP power plant can significantly

improve the performance of a conventional submarine when compared to a nuclear powered submarine, the current state of AIP technology places limits on key parameters such as patrol speed, burst speed, and submerged endurance.

When the United States committed itself to an all nuclear submarine force, it adopted the philosophy that these ships should be multi-mission capable. The LOS ANGLES class submarine exemplifies this mind set. Built for speed, this class of submarine was enhanced to improve its ability to keep pace with, and support a high speed carrier battle group, while maintaining the tools necessary to perform other submarine missions. The addition of vertical launch cruise missiles to the LOS ANGLES class has added yet another dimension to this formidable platform. Estimated SEAWOLF capabilities echo this commitment to a multi-mission platform.

It can be argued that the United States possesses the only true "blue water" navy in the world, and perhaps the only one requiring a sustained, high speed capability. Most nations with submarines are concerned with defense of their home waters, and have designed their navies accordingly. For example, Sweden's submarines operate in the Baltic Sea which is nominally 200 nautical miles (nm) wide with a maximum transit distance to patrol of 1000 nm. As a result, Sweden has incorporated a low power (2-75 kW Stirling Engines) AIP power plant in their submarine NAECKEN [20]. Canada has expressed interest in a long range AIP capability for its next generation diesel submarine to enable her to control the vast ocean basin underneath the Arctic ice cap, while Australia requires a similar long range capability of 9,000 nm to patrol and defend her expansive coastline [67, 68].

Missions compatible with the role of the submarine in the U S Navy include:

- Peacetime Engagement (show the flag)
- Surveillance
- Deterrence
- Regional Sea Denial
- Precision Strike Warfare
- Ground Warfare Support
- Unrestricted Submarine Warfare [62]

All of these missions can be performed by an AIP capable submarine.

Table 2.1 summarizes the operational capabilities of several classes of conventional and AIP capable submarines. Included in the table are designs already in service, as well as several designs not yet proven at sea. The operational characteristics of a LOS ANGELES class submarine are included for comparison to illustrate the impact of nuclear power on submarine design. As can be seen, many nations have settled on designs that are significantly smaller than the LOS ANGELES class submarine. It is also interesting to note that the conventional designs all have similar, albeit less capable operational characteristics, indicating the current limits placed on submarine design by AIP and/or diesel technology.

2.2 REQUIRED OPERATIONAL CAPABILITIES

In developing the actual concept design for a submarine, the "owner" or sponsor for the ship must specify what requirements the ship must meet to be considered an acceptable design. From the Milestone 0 approval for example, specific capabilities would be matched to the required missions for the submarine, Section 2.1 above, such as:

Table 2.1

Comparison of AIP/Conventional Submarines

	Los Angeles	Kilo	Walrus	Type 2400	Type 1700	Naecken	Collins
Country (Info. Source)	US a	USSR a	Netherlands b, c	UK b	FGR d	Sweden a	Australia e, f, g
Year in Service	1976	1980	1985	1986	1984	1980	1994
Submerged Displacement	6,927 tton	3,000 tton	2,800 tton	2400 tton	2,350 tton	1,085 tton	2,450 tton 3,000(AIP)
Length	360 ft	239.5 ft	223.1 ft	230.6 ft	216.5 ft	182.1 ft	249.3 ft
Diameter	33 ft	31.2 ft	27.6 ft	25 ft	23.9 ft	18 ft	26.2 ft
Diving Depth	1475 ft	1000 ft	> 1000 ft	>660 ft	> 1000 ft	1000 ft	> 1000 ft
Max. Subm. Speed	>30 knots	17 knots	20 knots	20 knots	25 knots	20 knots	20 knots
Shaft Horsepower	35,000 hp	6,000 hp	6,900 hp	5,360 hp	6,600 hp	1,800 hp	6,000 hp
AIP Power Source	Y Nuclear	N	N	N	N	Y Stirling	Planned PEM/Stirling
Mission Length	90 days	45 days	70 days	49 days	70 days	???	???
Complement	133 men	45 men	50 men	44 men	35 men	19 men	42 men
Range	Unlimited	9600 nm	10,000 nm	7,056 nm	10,000 nm	???	9,000 nm
Torpedo Tubes	4	6	4	6	6	8	6
Torpedo Reloads	22	18	24	12	20	12	???
Cruise Missile Mine Capable	Y / Y	Y / Y	Y / Y	Y / Y	N / Y	N / Y	Y / Y

- a. *Janes Fighting Ships 1990-91*, Capt. Richard Sharpe OBE RN ed., London, England.
- b. Stennard, J. K., *Comparative Naval Architecture of Modern Foreign Submarines*, Thesis, Ocean Engineering Department, Massachusetts Institute of Technology, May 1988.
- c. Anon., The WALRUS Launched-First of a New Class of Dutch SSK., *The Naval Architect*, Royal Institute of Naval Architects, London, England, January 1986.
- d. Anon., *Maritime Defence*. Volume 8, Number 4, April 1983.
- e. Anon., The Kockums Group, Advertising Supplement to *Janes Defense Weekly*, March 1994.
- f. Australian Collins Class Submarine Takes Shape, *The Naval Architect*, Royal Institute of Naval Architects, London, England, February 1993.
- g. The A19 and Type 471 Submarines from Kockums, *The Naval Architect*, Royal Institute of Naval Architects, London, England, May 1991.

<u>Mission</u>	<u>Capability</u>
Surveillance	Coastline and Open Ocean monitoring, Drug Interdiction
Ground Warfare	Seal Team Insertion and Recovery
Strike Warfare	Launch Cruise Missiles against land targets

In meeting these capabilities, operational performance parameters will be specified to give the naval architect measurable attributes upon which to base the design. This "Statement of Requirements" will also provide a range of acceptable values, from a "Goal" or optimum value for that characteristic to a "Threshold" or minimum acceptable value. A ship that does not at least meet all the threshold values established by the owner will generally not be accepted. The range of values specified for each requirement provide the latitude necessary for trading off capabilities. Table 2.2 illustrates a typical Statement of Requirements for an AIP submarine.

The final piece of logic to be communicated in this statement of owner's requirements is the priority to be assigned to the attributes which are mutually exclusive of each other. This design philosophy is usually stated in some form of hierarchy, assigning relative weights to the attribute the owner considers most important. This concept is illustrated in Table 2.3.

With the required missions determined, the required capabilities in several areas stated and the relative priority for meeting the desired capabilities established, the design team can proceed with concept exploration.

As an example of the type of trade-offs to be made, consider submerged endurance on the battery. For a given battery type, increasing endurance for a given speed on battery power alone means increasing the battery size, weight and cost. If the battery is larger, the ship size may have to be increased to

Table 2.2
Statement of Requirements

Requirement	Goal	Threshold
Diving Depth	1000 feet	700 feet
Range: Snorkeling @ 10 kt SOA	15,000 nm	10,000 nm
Submerged @ 8 knots (AIP)	30 days	20 days
Submerged @ 4 knots (battery)	120 hours	90 hours
Submerged @ maximum speed	5 hours	2 hours
Endurance	90 days	60 days
Speed: Submerged, maximum	24 knots	20 knots
Snorkeling, sustained	12 knots	10 knots
Surfaced, maximum	15 knots	12 knots
Indiscretion Rate: Transit @ 10 knot SOA	0.3	0.4
On station @ 8 knots	0.05	0.1
Weapons: Number of Torpedo Tubes	6	4
Total Weapons Load	24	16
Weapons Type	≥ Threshold	Torpedoes/Cruise Missiles/Mines
Manning	40 men	50 men
Main Ballast Tank Volume (% of everbuoyant volume)	15	12
Lead Ballast (% of normal surfaced condition)	10	5
Lead Ship Cost	\$500 Million	\$600 Million

support the increased battery weight. Increasing both the battery and ship size will most likely increase the cost of the ship. By Table 2.3, cost is a higher priority (10) than battery endurance (8). Therefore after the impact of increasing battery endurance on the overall ship cost is studied, one might expect that battery endurance would be sacrificed to keep costs down.

Table 2.3
Design Philosophy

Requirement	Relative Weight
Mission Payload Performance	10
Cost	10
Maximum Speed	9
AIP Endurance	9
Battery Endurance	8
Risk	7

2.3 SUBMARINE HULL SYNTHESIS

With the ships requirements stated, the process of determining the size of the submarine can begin. While the details of the submarine model will be discussed in Chapter 6, the basic concept of submarine hull generation will be presented here to give a better understanding of the impact of the AIP propulsion options, power sources and reactants on submarine design when explained in Chapters 3, 4 and 5.

For this thesis, the shape of the hull will be assumed to be a body of revolution, modeled after the hull of the submarine ALBACORE. This basic shape has the best underwater hydrodynamic performance, which will be important to best utilize the power available from the AIP power plant.

Even though a modern submarine is designed to spend most of its operating time submerged, Archimedes' principle for flotation of hull weight is applicable in both regimes. As seen in Figure 2.2, the first logical step from ship

requirements is weight estimation. Extensive data bases have been developed which catalogue existing equipment and structural weights. From these data bases, parametric curves have been developed which can be used to estimate each of seven major weight categories, which form the fixed weight of the ship. To this fixed weight is added lead ballast, part of which is used to balance longitudinal moments later in the design process and part to allow for weight growth in equipment over the life of the ship. Also to be accounted for are the variable weights on the ship, which include fluids; such as fuel and fresh water, stores; such as food and spare parts, and weapons. This summation of weights represent the total weight which must be supported at all times when the ship is on the surface and is designated as the normal surfaced condition (NSC). The left hand column of Figure 2.3 summarizes this weight summation process.

Similar to the weight estimation database, data exists for the pressure hull volume necessary to enclose the equipment, crew and weapons carried by the ship. From these volumes, established parametric relationships are employed to estimate the pressure hull volume. Add to this volume all the items such as ballast tank structure, hull plating and equipment which exist outside the pressure hull and you have the portion of the ship which will never flood with water and is termed the everbuoyant volume (V_{EB}). The everbuoyant volume is equivalent in concept to the NSC and is the point where estimated weights and volumes are reconciled. For the ship to achieve neutral buoyancy, the estimated weight of the ship must equal the weight of seawater displaced by the everbuoyant volume. If NSC is greater than V_{EB} , the ship is said to be weight limited, with the ship not displacing enough water to float the submarine on the surface. If V_{EB} is greater than NSC, the ship is said to be volume limited with the ship requiring more weight to achieve neutral buoyancy. To bring these two

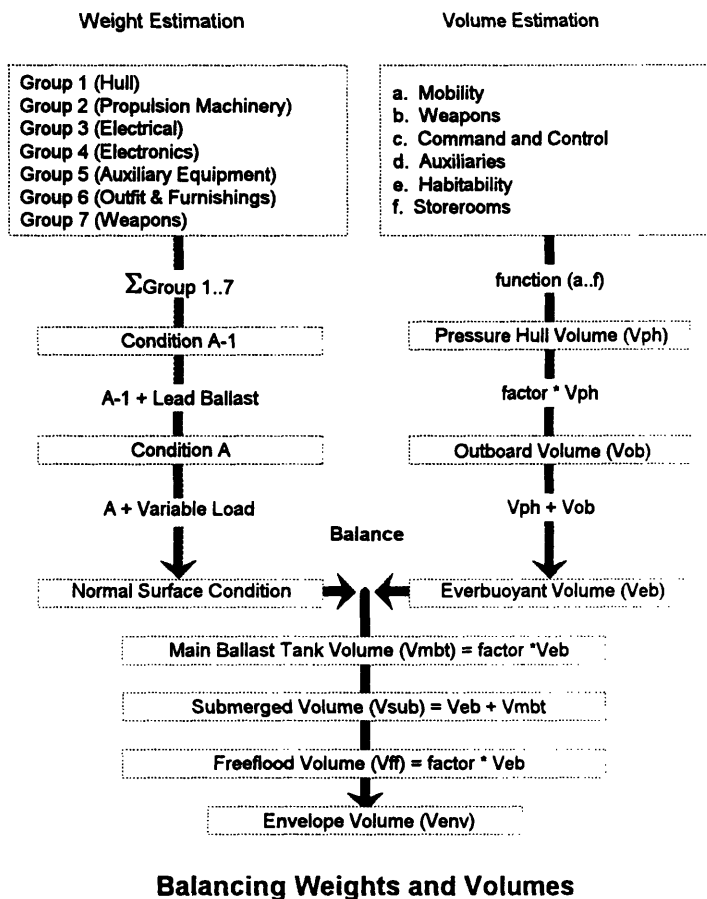

Figure 2.3

concepts together, either volume is added to the weight limited ship, or lead ballast added to the volume limited ship, rather than immediately refining any estimates made of the weights and volumes. When the best value for V_{EB} has been established, the margin required for main ballast tank volume is applied, along with an estimate of the volume of the ship which is free flooding on submerging to obtain the volume of the hull envelope. This envelope represents the hull form and weight that must be propelled by the ship when submerged and forms the starting point for the powering calculations.

The next several steps refine the estimates made above in determining weights and volumes. To begin, the chosen hull form from above, corrected for

added appendages is used to estimate the effective horsepower (EHP) of the ship. EHP is the power necessary to push the hull through the water at various speeds. The choice of propulsor and efficiencies associated with water flow past the stern and propeller combine to estimate the propulsive coefficient (PC), a measure of how effective the propeller is in converting the available shaft horsepower (SHP) to EHP. With SHP determined, a check of the initial propulsion machinery estimate can be made. Likewise, a preliminary set of arrangement drawings is made to ensure compartment layouts are sensible, to locate weights and calculate moments to check the longitudinal stability of the ship. Additionally with the principal hull dimensions known, the pressure hull and its required scantlings can be estimated to refine initial estimates for structural weight.

Finally, the dynamic performance of the ship is evaluated through the use of computer simulation and model testing to verify that the hull form and the first estimate of sail and control surface size and location result in acceptable underwater performance. Upon completion of this final check, the first trip around the design spiral is complete. Now the design team must come together to compare results, perform trade offs guided by the design philosophy, and make any necessary changes to the initial weight and volume estimates. With these revised values, the procedure just outlined is revisited, with the end result being a more balanced ship. This circular procedure is repeated until the best design is produced.

CHAPTER THREE

3.0 SUBMARINE SYSTEMS

The systems required to support a submarine's operating profile contain many aspects of those found in standard shipboard applications. These systems are however complicated by the special considerations unique to submarine operations, such as buoyancy systems for diving and surfacing and atmosphere control. Conventional system designs are comprised of a central plant (electric, hydraulic, pneumatic, etc.) and some form of distribution / energy storage network. Systems of this type are important for several reasons, a primary one being the conservation of space and power, since a hydraulic operator for a valve is many times smaller than an equivalent motor operator. A general description of the more important systems will be presented to provide a background for the AIP plant size decisions.

The integration of a shipwide electrical system with propulsion and ship service requirements is most critical to the make up of a conventional submarine. Relying on different power sources at different times in an operating profile, these sources must be capable of providing continuous power in parallel, whether in transition between sources or together to increase the available output power. The types of power available, and the load requirements go a long way in determining the architecture of the system.

Power sources, discussed in detail in Chapter 4, include electro-chemical which provide a direct current (DC) output and mechanical, which can be fitted with either an alternating current (AC) or DC generator to provide electrical power. Ship service electrical loads, Section 3.2, depend on the type of equipment application, but are generally some form of 60 or 400 cycle AC or DC

power. Propulsion loads have been predominantly DC power based, but emerging technology has pushed AC and low voltage high current DC power applications to the forefront, and are discussed first in Section 3.1.

3.1 PROPULSION INTEGRATION

Table 3.1 presents a summary of possible propulsion options to be considered in this study.

TABLE 3.1
Propulsion Options

Propulsion Type	Attributes	Technology Status
Conventional DC	220 - 880 VDC	Mature, proven at-sea service for many years
Permanent Magnet AC	800 VAC, Variable Frequency	Near maturity, foreign shipboard installations planned
Superconducting Homopolar DC	100 - 200 VDC 100 - 200 kAMPS	Immature

3.1.1 CONVENTIONAL DC

Advantages	Disadvantages
-Reliable Technology -Compatibility with Battery Systems	-Large Weight/Volume

The most common arrangement in service is the conventional DC motor from a high voltage (220 - 880 VDC) bus, which until recently was the only viable technology available. Double armature motors with creative battery switching

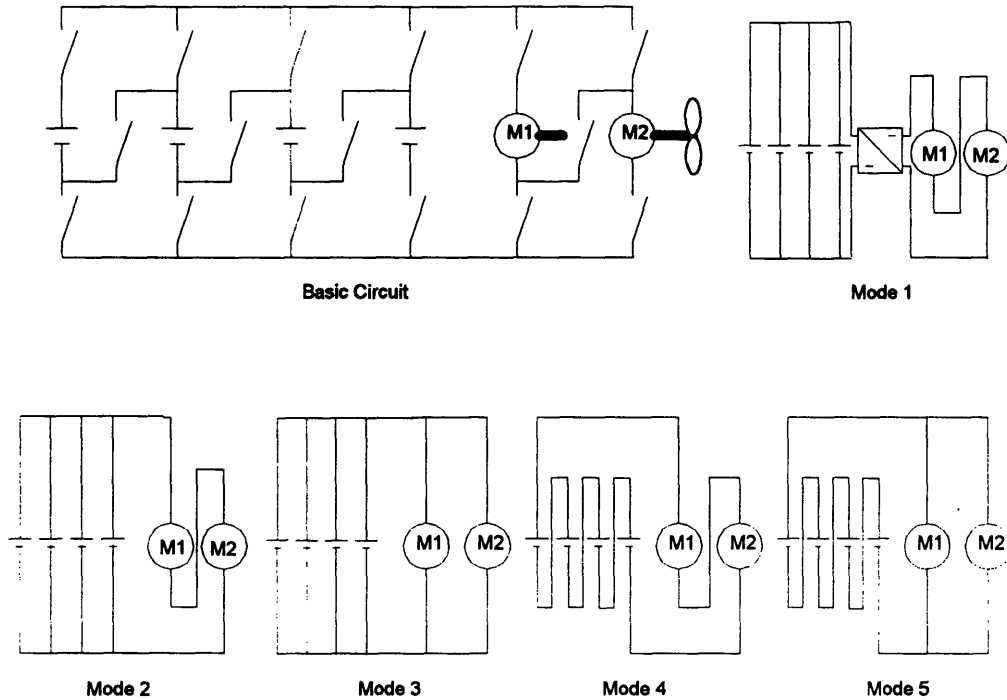

Battery Stepping Operating Modes for a Double Armature DC Motor [27]

Figure 3.1

schemes such as Figure 3.1 gives the operator flexibility in terms of speed control and system configuration. Based on its vast historical operating experience, this concept is well proven in terms of reliability. While improvements have been made, these machines are heavy and volumous when compared to AC machines of similar power output. Their widespread use however is a result of their excellent low speed torque characteristics and their ready compatibility to the varying DC voltage characteristics of the traditional Lead-Acid battery based electrical distribution system.

3.1.2 PERMANENT MAGNET AC

Advantages	Disadvantages
<ul style="list-style-type: none"> -Reduced Weight / Volume -Heat Losses in Rotor Eliminated 	<ul style="list-style-type: none"> -Requires DC/AC Inverters -Heat limits in PM materials -Current collectors not mature

Permanent Magnet AC (PM) motor technology is being developed and may gain acceptance as the possible successor to the conventional DC system. The PM motor, illustrated in Figure 3.2 uses permanent magnets to

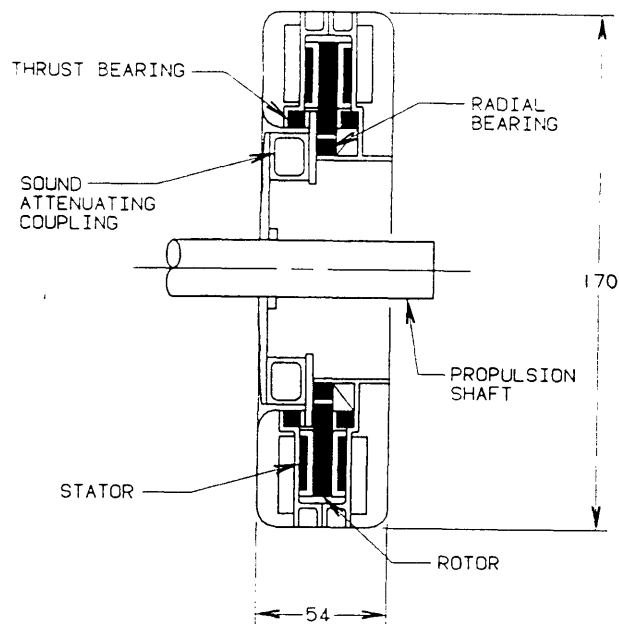

Permanent Magnet Axial Gap Propulsion Motor [16]

Figure 3.2

replace the magnetic field source on the rotor eliminating significant amounts of electrical wiring. In this design the rotor, and stator are disc shaped vice a conventional can shaped stator encircling the rotor core. With the disc geometry, a larger number of poles can be included, with smaller end turn volumes and reduced stator back iron size and weight, giving the motor a higher degree of speed control. Estimates of the weight and volume savings for PM motors over comparable DC motors are on the order of 50 and 40 percent, respectively [28]. This technology can also be applied to power generation applications with similar savings in weight and volume. Figure 3.3 illustrates one concept design currently under evaluation at the Naval Surface Warfare Center, Annapolis [18]. The cup shaped rotor with the stator located inside is designed to counter centrifugal forces generated by spinning the rotor magnets at speeds up to 12,000 revolutions per minute (RPM).

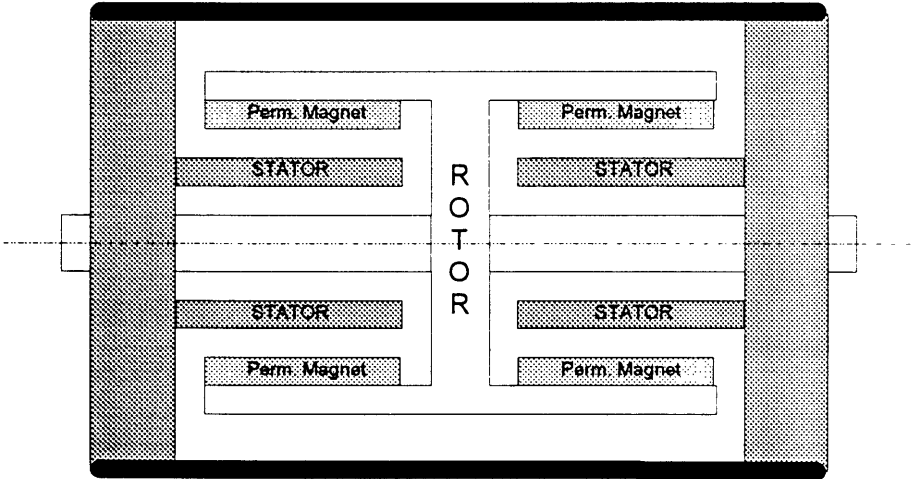

Permanent Magnet High Speed Generator

Figure 3.3

PM motors, however, require a slowly varying AC frequency that will allow the motor to operate at very low speeds. This frequency can be achieved

through the use of power electronics to chop a DC input signal to provide an output AC voltage of the appropriate frequency, Figure 3.4. Alternately, this AC voltage can be created by using a DC motor - AC generator set, varying the speed by control of the DC motor field.

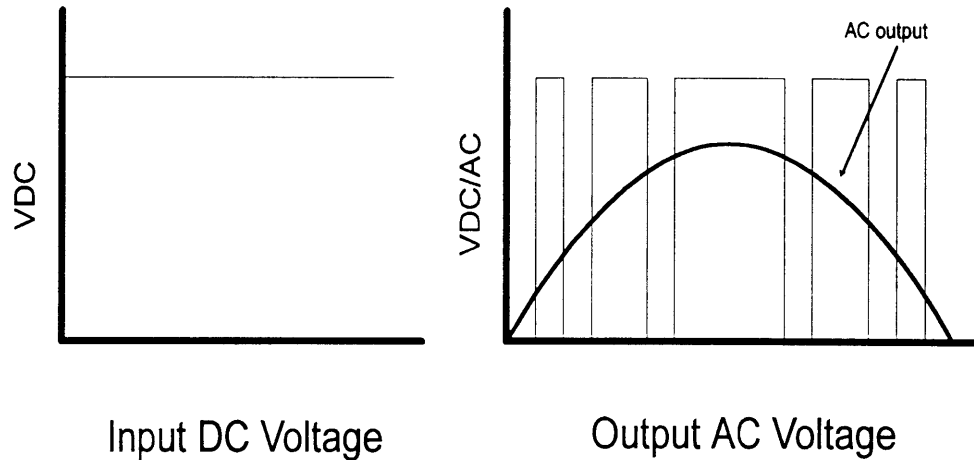

Example of Chopped AC Output From Input DC

Figure 3.4

3.1.3 SUPERCONDUCTING HOMOPOLAR DC

Advantages	Disadvantages
<ul style="list-style-type: none"> -Reduced Weight / Volume -Reduced Noise / Direct Mounting to hull 	<ul style="list-style-type: none"> -Requires Cryogenic Cooling -High electrical currents -Current collectors not fully developed

While still an immature technology in its final form, the Superconducting Homopolar (SC) motor is a next generation of propulsion technology, taking advantage of "zero" resistance properties of electrical conductors when they have been cooled to near zero degree Kelvin conditions. The SC motor illustrated in Figure 3.5 is currently under development at the Naval Surface

Warfare Center, Annapolis [6]. Employing basic Lorentz force principles, the motor contains large super conducting coils in a stationary cryostat cooled to 4°K , generating a torroidal magnetic force which appears radially outward in the active region of the motor. Because the resistance of the coils is very close to zero, a large current can be applied creating a very strong magnetic force for the stator current to operate against. This allows the motor to generate very large values for torque relative to the size of the machine. To the detriment of the concept, the cryostat, which contains liquid helium requires a separate cryogenic plant to maintain the temperature which draws approximately 100 kW of power, a significant penalty in an AIP application. Also, the current collectors, which are Sodium-Potassium liquid metal, are sensitive to water absorption causing corrosion problems and disperse under high rotational speeds.

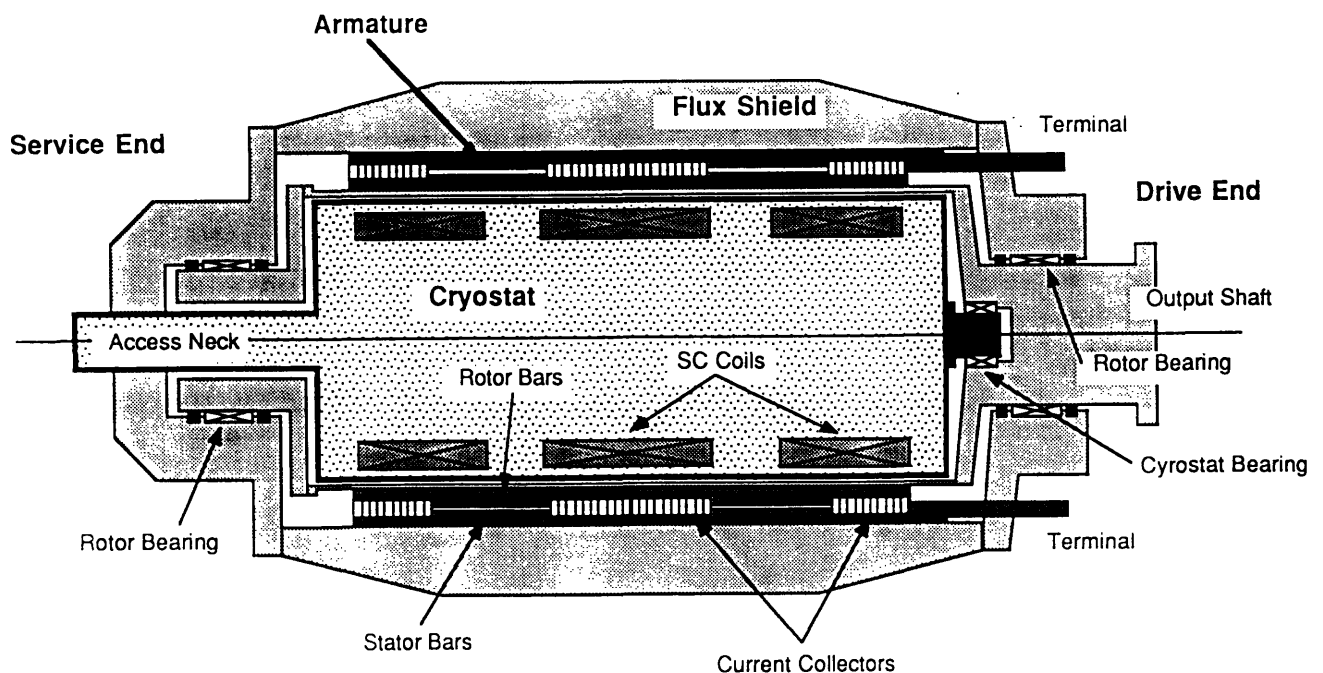

Superconducting Homopolar DC Motor

Figure 3.5

3.1.4 PROPULSORS

The standard submarine propulsor is of fixed pitch design, specially designed to minimize the effects of cavitation while submerged. Other styles of propulsors, such as contra-rotating (CR) or ducted propellers have been proposed and installed on submarines, but problems of one type or another have kept them from gaining acceptance. The CR propeller offers a 10 percent increase in the propulsive coefficient for a submarine application [12]. Historically, the problem with a contra rotating system has been the transmission of power through some form of reduction gear to the propulsion shaft. The emergence of PM and SC technology, with its compact design, offers a good solution to this dilemma [19].

3.2 SHIP SERVICE POWER REQUIREMENTS

While the propulsion load will vary constantly, the ship service or hotel load of the submarine will remain fairly constant for a given operating profile. Included in this hotel load are the minimum power requirements for ship control and operation and atmosphere control. These loads can be expected to vary for each operating profile of the ship, such as a battle station condition when all crew members are on station and most systems are operating, to an ultra quiet condition when most crew members are retired and only a minimum number of systems are operating.

Most equipment is operated by some form of electricity from a ship service bus. Conventional submarines generally employ ship service busses that are DC power based because of their link to the storage battery, thus any load that cannot operate off a DC voltage source that varies with the state of charge on the battery must be converted. Motor generator sets or static power inverters are utilized to convert DC power to its required form, such as:

Power Type	Typical Loads
120 VAC, 60 cycle	Bilge Pumps, Lighting, Atmosphere Monitoring Equipment, Appliances
450 VAC, 60 cycle	Ventilation Fans, Hydraulic Pumps, Air Compressors, Galley Equipment
120 VAC, 400 cycle	Precision Electronic Equipment (Gyro compass, weapons control, etc.)
High Voltage DC (Direct from Battery Bus)	Trim Pumps, Lube Oil Pumps, Lighting
Low Voltage DC	Ship Control, Sonar Equipment Power

The loads above are typical of those developed for nuclear powered submarine applications which use an AC ship service bus, and for some uses be adapted to a different more convenient source. Figure 3.6 illustrates a typical ship service power architecture.

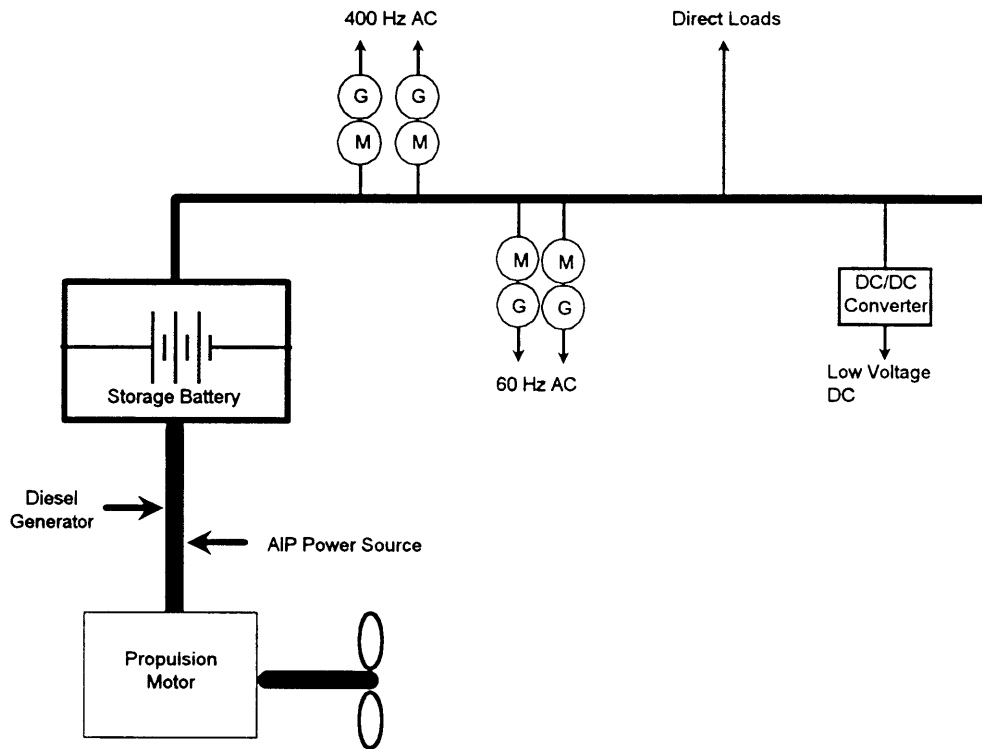

Typical Ship Service Distribution System

Figure 3.6

3.3 AUXILIARY SYSTEMS

The electrical distribution network is but one small part of the vital submarine support network. A fully integrated system of pneumatic and hydraulic controls and operators supplements the ship operations, providing compact, high powered operating mechanisms for large equipment such as diving planes, masts and antennas and seawater valves. Most systems are comprised of a central power plant where the energy of that system is created, then distributed to various operating points or to storage locations. For example, a typical hydraulic system features a storage tank, pump and high pressure accumulator all in one package which then feeds a hydraulic distribution system, Figure 3.7. A typical pneumatic system features air compressors connected to a high pressure air header, which feeds high pressure air storage bottles and a distributed network of lower pressure air systems, Figure 3.8. Here the air storage bottles are spread throughout the ship, typically in the vicinity of the main ballast tanks to provide an immediate emergency source of surfacing air. These types of systems are important supplements to the electrical network because of their simplicity in operation, their reliability in the face of a propulsion plant casualty, and the energy density available in the high pressure fluids they contain.

3.4 ATMOSPHERE CONTROL

A vital distributed auxiliary system, but one which seems far less defined is the ventilation / atmosphere control system. This system comprises the necessary fans and ductwork to bring air into the ship, recirculate it when submerged and purify it so that the air continues to be breathable. All submarines have similar arrangements, however AIP variants must contend with the additional concern of air revitalization, that is the removal of contaminants

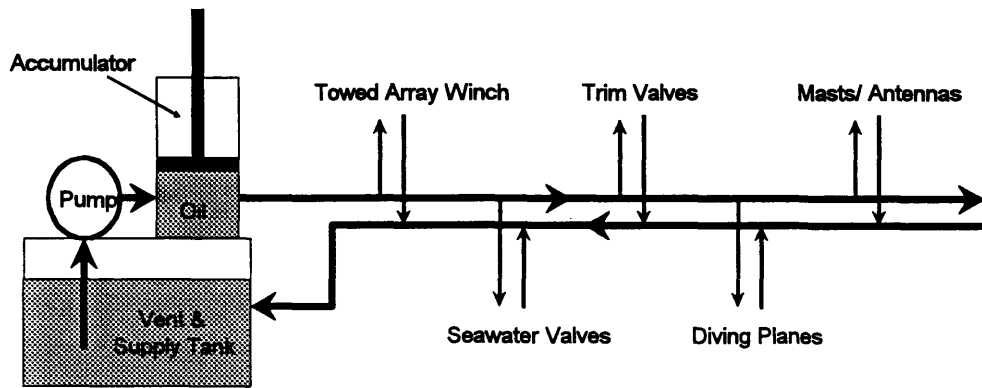

Hydraulic System with Typical Loads

Figure 3.7

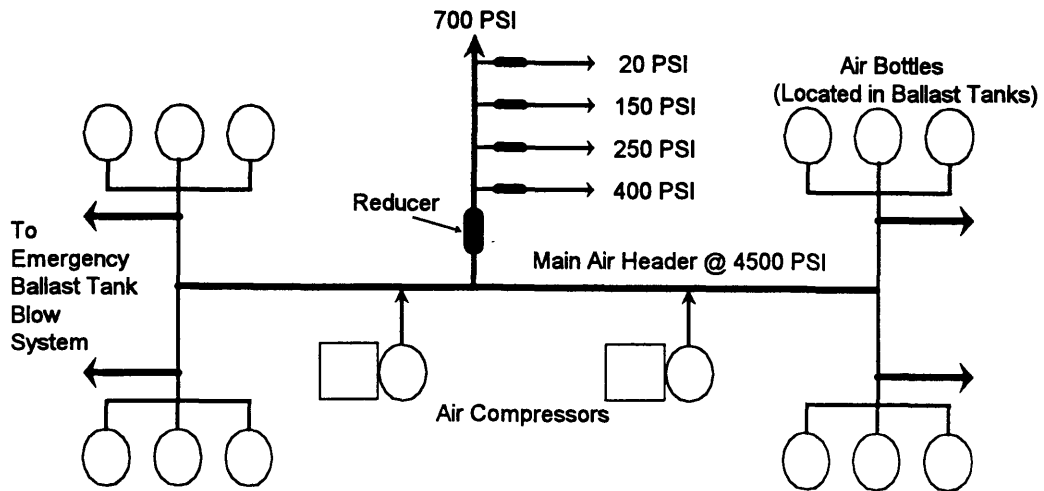

High Pressure Air System

Figure 3.8

such as carbon dioxide (CO₂), carbon monoxide, hydrogen and odors, and replacing the oxygen consumed by the crew. Conventional diesel submarines rely on the fact that they snorkel periodically and use that opportunity to exchange air with the atmosphere and are therefore concerned with how to bridge the gap between snorkel evolutions. These ships typically employ Chlorate Candle canisters which are burned to produce oxygen and a chemical reactant such as Lithium Hydroxide to absorb CO₂. An AIP submarine could employ similar methods for atmosphere control, but storage requirements for these expendable canisters could limit the submarine's endurance. Since it will be shown that some AIP options include liquid oxygen storage, this tankage can be increased by the necessary amount to include breathing oxygen for the crew for the entire patrol, estimated to be 0.030 ft³ of liquid oxygen per person, per day of patrol [7]. This parasitic use has an additional advantage in that it can be used as a load for the boil off that occurs during normal storage of oxygen as a liquid. CO₂ removal can be accomplished by the use of scrubbers which use a monoethanolamine (MEA) spray to absorb CO₂ from the air, releasing it to an overboard discharge system. Such a system is regenerable, however its penalty is an additional electrical hotel load on the order of 6 kW. Also of concern is the potential build up of hydrocarbons and hydrogen gas which can be cleaned up through the use of burners, again at an electrical cost of about 9 kW [71].

By locating this atmosphere control equipment in one location, the air can be recirculated throughout the submarine and passed through this "room" to be revitalized. Oxygen can be bled into the submarine at various locations so help distribute it evenly throughout the ship. Figure 3.9 represents a typical ventilation arrangement.

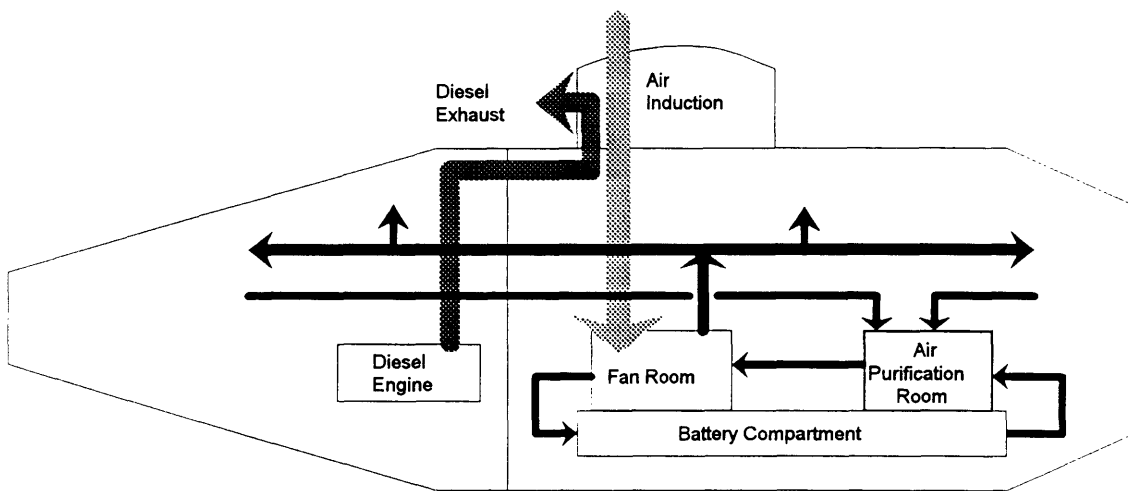

Ventilation Arrangement

Figure 3.9

(Blank Reverse)

CHAPTER FOUR

4.0 POWER SOURCES

Many AIP power plants have been proposed, with development conducted by those countries that have a genuine interest in promoting air independence for their own submarines or for the commercial submarine market. This chapter investigates current and proposed power source options.

An AIP power plant is composed of several parts combined into one functional system. These parts are:

- Energy conversion device
- Fuel source
- Oxidant source
- Waste product management.

Reactants, which include fuels and oxidants, and waste product management, which can involve the storage of pure water or discharging high volumes of carbon dioxide overboard will be examined in Chapter 5.

The energy conversion device can be categorized as either electro-chemical or mechanical, depending on how the energy conversion is performed. Mechanical AIP concepts include compact heat engines modified to run in the absence of a normal atmosphere such as the closed cycle diesel, to entire cycles, such as a Rankine cycle whose heat source is a simple combustor burning hydrogen and oxygen. A discussion of these plants can be found in Section 4.2. Electro-chemical concepts include a range of fuel cell and high performance primary and secondary battery options and will be discussed first.

4.1 ELECTRO-CHEMICAL CONCEPTS

Table 4.1 summarizes the electro-chemical power concepts to be investigated.

Table 4.1
Electro-Chemical AIP Concepts

Power Sources (Electro-Chemical)	Remarks
Proton Exchange Membrane Fuel Cell	Most promising H ₂ -O ₂ cell
Alkaline Fuel Cell	Proven design
Phosphoric Acid Cell	Proven design, low interest
Molten Carbonate Fuel Cell	Several commercial ventures underway
Solid Oxide Fuel Cell	Immature, highest projected efficiency
Aluminum Oxygen Semi-Cell	Competitive with PEM cell
Lead Acid Battery	Proven performance
Nickel Cadmium Battery	Higher power density than lead acid
Silver-Zinc Battery	Prone to short circuits
Lithium-Aluminum/Iron Sulfide Battery	Potential successor to lead acid

4.1.1 FUEL CELLS

Fuel cells represent a major area of interest among AIP power source options, presenting a potential for very high efficiencies since the energy conversion process is not limited by Carnot principles. As seen in Figure 4.1, their projected efficiency is roughly double that seen with heat engine cycles, which can translate into large savings in fuel and oxidant for a given submarine hull [29]. A fuel cell can be thought of as a black box where chemical reactants

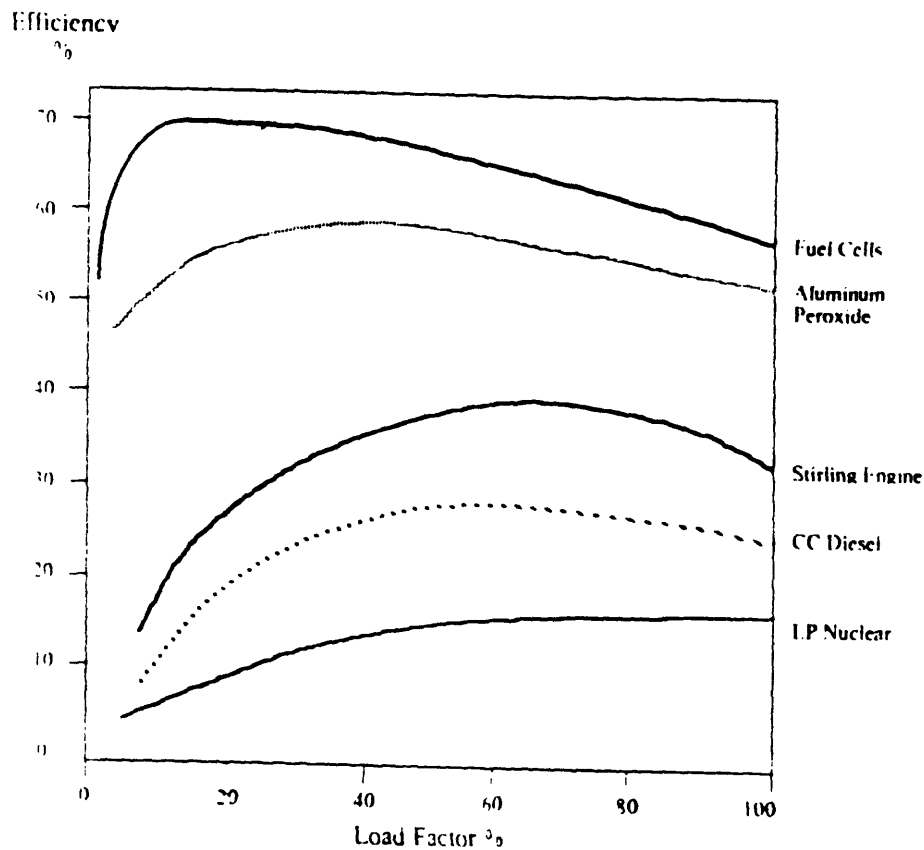

Efficiency vs. Load for AIP Options

Figure 4.1

are introduced and combined, utilizing an electrical load to complete the transfer of electrons between anode and cathode, thereby creating a DC electrical power source. There are many proven fuel cell designs over a wide range of power levels, however the auxiliary equipment necessary to support these cells, and the materials themselves may not be compatible with submarine applications. As a result, only those technologies which appear to be favorable will be considered.

4.1.1.1 PROTON EXCHANGE MEMBRANE FUEL CELL

Advantages	Disadvantages
<ul style="list-style-type: none">-Proven technology-"Solid" cell technology-Quiet / reduced heat rejection-Pure water product-Low operating temperatures (180°F)	<ul style="list-style-type: none">-Hydrogen storage-Requires pure reactants-Reformer for non-hydrogen fuels (immature)-Cell poisoning due to impurities reduces output

The Proton Exchange Membrane (PEM) cell is presently the most popular fuel cell in terms of interest and development for submarine applications. This thought is underscored by German industry, which after successfully demonstrating a small alkaline fuel cell plant in a Type 205 submarine in 1987, has abandoned that variety of cell in favor of the PEM cell [29]. The PEM cell is also being studied as a part of AIP development programs in the United Kingdom, Canada and Australia. In addition, the US Navy has developed PEM technology for replacement of alkaline cell technology in the oxygen generating equipment found onboard its nuclear submarines [55].

The PEM cell is a standard hydrogen-oxygen cell, depicted in Figure 4.2, except that the electrolyte is actually a solid polymer material rather than a liquid ionic material such as potassium hydroxide or phosphoric acid. Hydrogen is introduced at the anode where a catalyst forces the release of electrons. Hydrogen ions then pass through the polymer material to the cathode where they combine with oxygen and free electrons to form water. The electrical circuit is formed by insulating the anode and cathode electrically, forcing the electrons released at the anode to transit via an electrical circuit to the cathode where they are required to complete the reaction [13].

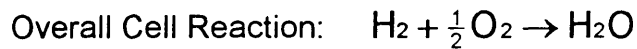
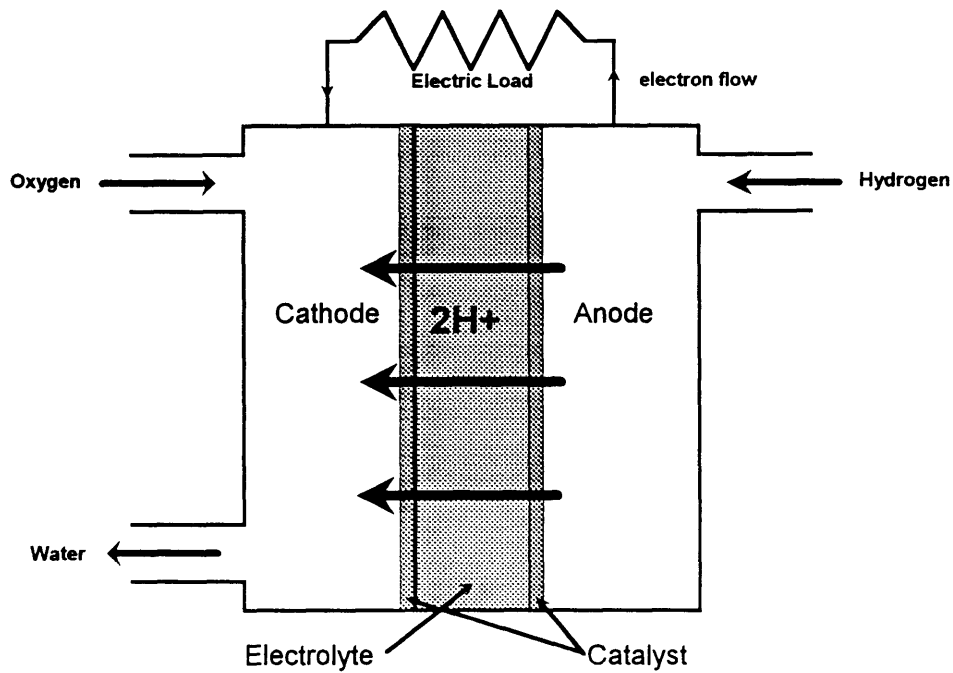

Proton Exchange Membrane Fuel Cell [39]

Figure 4.2

The size of the fuel cell is flexible and can be tailored to the application. While most specific information is proprietary, a single fuel cell can be expected to generate an output voltage of slightly less than 1.0 VDC with a current density on the order of 1 amp per square centimeter. Thus for a certain power requirement, individual cells can be connected in series to achieve the required output voltage, with enough active area to achieve the required amperage (power) rating. Figure 4.3 shows a typical cell voltage versus load profile.

The PEM cell requires relatively few auxiliary systems to support its operation. The electrolyte is solid, requiring no makeup or monitoring system as

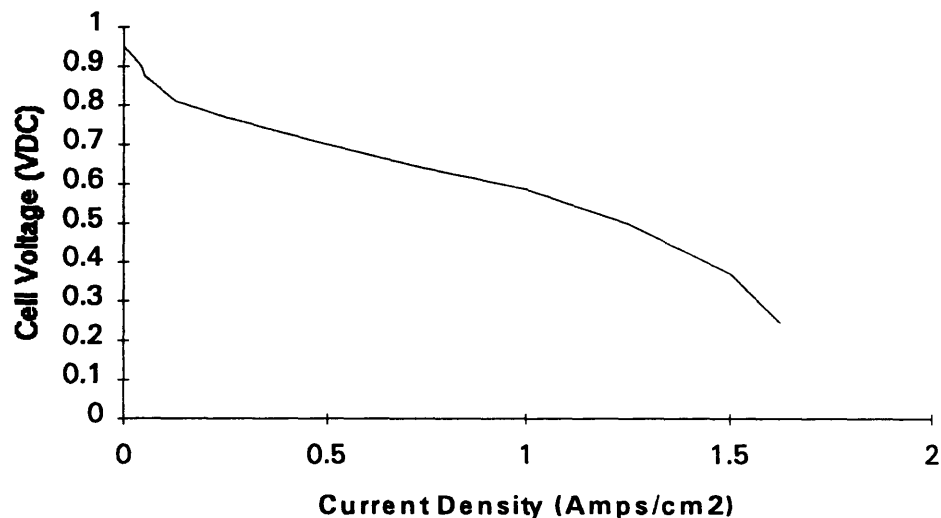

PEM Cell Voltage versus Cell Load [74]

Figure 4.3

in liquid electrolyte designs, greatly improving its simplicity. The cell is classified as low temperature in comparison to other systems. With an operating temperature around 200°F, the time required for the cell to reach operating temperature is relatively short, making it ideal for rapid start-up, an important operating characteristic. The lower operating temperature is also more compatible with an enclosed submarine environment [44]. The only product discharge from the cell is pure water, which is potable and easily handled, either by storage for crew consumption or transfer to a variable ballast system for discharge overboard. A significant issue for the PEM cell is the fuel source. The solid polymer electrolyte membrane is susceptible to contamination by impurities in the fuel gas, specifically carbon monoxide, a by-product of the reformation process. While carbon monoxide contamination does not permanently damage the cell, concentrations as high as 10 PPM can

dramatically affect cell performance, requiring regeneration of the cell with a clean gas source [3]. Development of a "clean" reformer is a significant developmental issue and is discussed further in Section 5.1.1.3.

Specific details on the PEM cell can be found in Appendix A.

4.1.1.2 ALKALINE FUEL CELL

Advantages	Disadvantages
<ul style="list-style-type: none"> -Demonstrated performance "at-sea" -Quiet / reduced heat rejection -Pure water product -Low operating temperatures (180°F) 	<ul style="list-style-type: none"> -Hydrogen storage -Liquid electrolyte / more complex than PEM -Requires pure reactants -Reformer for non-hydrogen fuels (immature)

This fuel cell is very similar in concept to the PEM cell with exception of the electrolyte and its added complexities, and has been demonstrated to operate successfully at sea in a German Type 205 submarine. This system used potassium hydroxide to conduct the hydrogen ions to the cathode for recombination [55]. Figure 4.2 presented earlier for the PEM cell applies to the alkaline cell as well.

4.1.1.3 PHOSPHORIC ACID FUEL CELLS

Advantages	Disadvantages
<ul style="list-style-type: none"> -Demonstrated commercial performance -Quiet / reduced heat rejection -Pure water product -Can reform hydrogen fuels internally 	<ul style="list-style-type: none"> -High operating temperatures (400°F) -Liquid electrolyte / more complex than PEM -Larger / heavier than PEM, same efficiency

Another variant of the basic hydrogen oxygen fuel cell is the Phosphoric Acid Fuel Cell (PAFC), which is conceptually similar to the alkaline cell, using phosphoric acid as an electrolyte. While this cell is fueled by pure hydrogen, variants operated at higher temperatures (400°F) may be able to reform hydrogen based fuels internally as this cell is not susceptible to carbon monoxide poisoning [21]. Commercial development of the PAFC as a "portable" remote power source fueled with natural gas is mature. At issue for submarine applications are the significantly larger volumes and weights for similar efficiency when compared to PEM technology and lower efficiency when compared to other similar sized high temperature cells to be discussed [65].

4.1.1.4 MOLTEN CARBONATE FUEL CELL

Advantages	Disadvantages
<ul style="list-style-type: none"> -Internal conversion of fuel -Variety of fuels possible -Higher system efficiencies -High system temperatures utilized in fuel reformation -Active commercial interest -Can support bottoming cycles 	<ul style="list-style-type: none"> -High operating temperatures (1200°F) -Safety to personnel -Long start up time -Corrosion issues -Large/heavy compared to other fuel cell plants

The Molten Carbonate Fuel Cell (MCFC) is similar to other fuel cells in its basic principle of operation, however its method of achieving energy conversion

is quite different. Illustrated in Figure 4.4, the MCFC utilizes a molten carbonate salt as the electrolyte, and thus must be heated to around 1200°F to function. If properly insulated, this high heat can be used to internally reform any number of hydrogen based fuels, such as marine diesel or methanol, making this option especially attractive. Similar to the PEM cell, pure water is produced as a result of the reaction, however other products, such as carbon dioxide are produced as well. The relative volume of carbon dioxide gas produced depends on the type of fuel used in the cell. Because of the high temperature of the cell, the waste heat from the cell can be used to operate some form of bottoming cycle, improving overall system efficiency [65].

Appendix A contains more specific data on MCFC

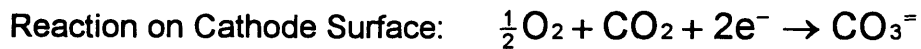
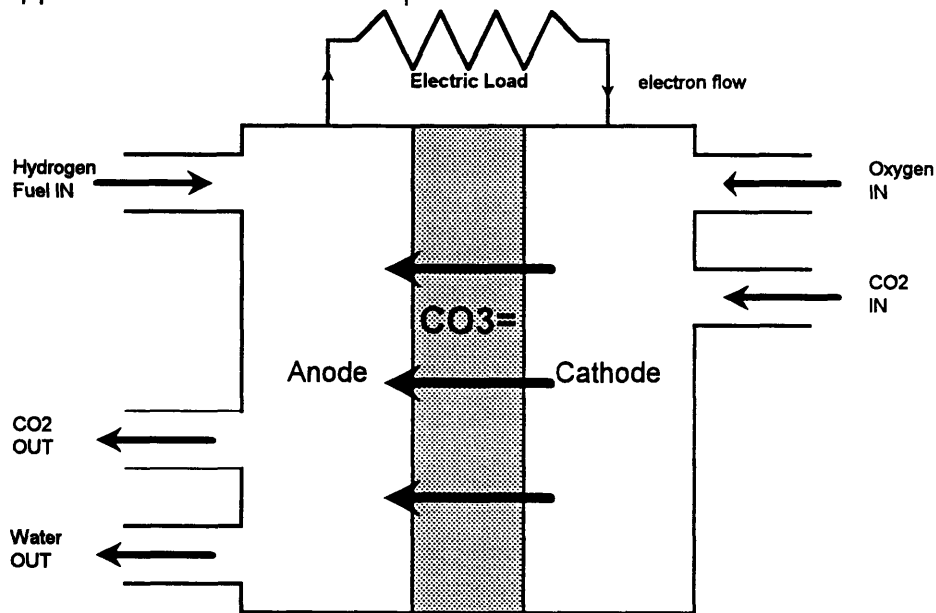

Molten Carbonate Fuel Cell

Figure 4.4

4.1.1.5 SOLID OXIDE FUEL CELL

Advantages	Disadvantages
<ul style="list-style-type: none">-Internal conversion of fuel-Variety of fuels possible-Highest system efficiency (projected)-High system temperatures utilized in fuel reformation-Can support bottoming cycles	<ul style="list-style-type: none">-Immature technology-High operating temperatures (1800°F)-Safety to personnel-Long start up time

The Solid Oxide Fuel Cell (SOFC) is a new, advanced technology which is still very immature. Similar to the MCFC, it operates at high temperature (1800°F) and can therefore internally reform various types of fuel. Its electrolyte however is a solid, nonporous metal oxide, eliminating the need for a liquid electrolyte management system. The higher operating temperature of the SOFC promises that it should enjoy a higher efficiency than the MCFC, and projections are that SOFC technology should be very weight and volume efficient [65]. One design by Westinghouse for possible shipboard applications is shown in Figure 4.5. Here an oxidant is passed inside a cylindrical cell with the fuel gas passed on the outside. Similar to other fuel cell applications, the ceramic metal oxide passes oxygen ions through to the cathode where they combine with hydrogen and carbon monoxide to form carbon dioxide and water.

4.1.1.6 DIRECT METHANOL OXIDATION FUEL CELL

This cell represents research in PEM technology aimed at eliminating the reformer requirement when using fuels other than pure hydrogen. It is very immature and is not formally evaluated in this study.

The cell operates at low temperature and contains the solid polymer electrolyte. The difference is a special catalyst at the anode which transforms methanol fuel into hydrogen and carbon dioxide, a gas with no effect on cell efficiency. Present cell performance has an output voltage of 0.6 VDC (slightly less than PEM) at a current density of 0.1 Amps/cm² (1/10th of the PEM cell) [37].

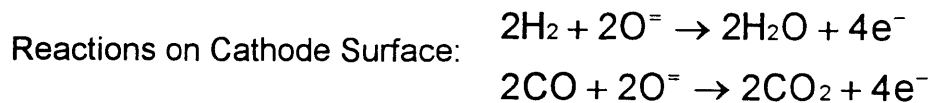
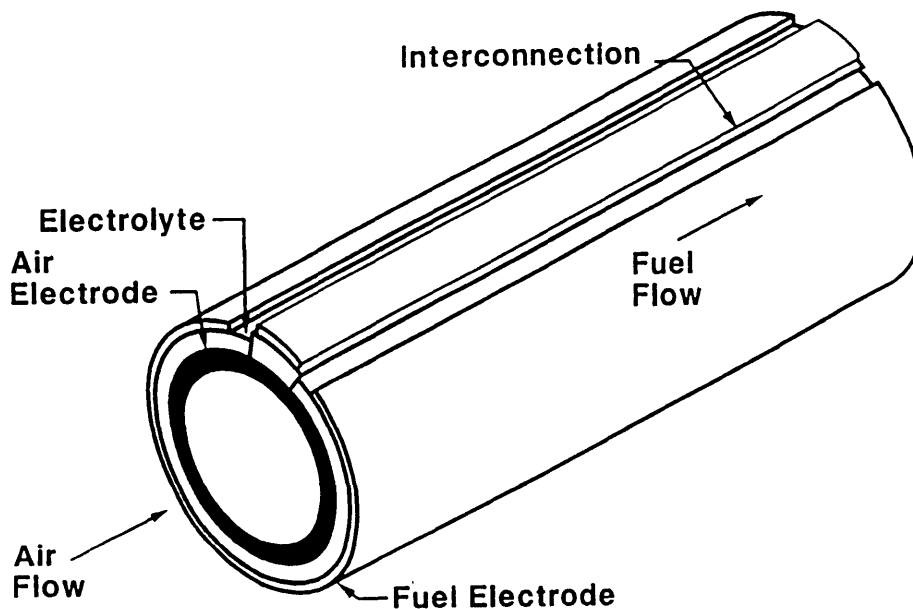

Westinghouse Solid Oxide Fuel Cell [5]

Figure 4.5

4.1.2 ALUMINUM OXYGEN SEMI-CELL

Advantages	Disadvantages
<ul style="list-style-type: none">-No hydrogen required-No products discharged/net weight unchanged with time-Requires one half the oxygen of other comparably sized fuel cells-High density fuel source	<ul style="list-style-type: none">-Expensive fuel-Frequent cell replacement-Hydrargillite management-High cell weight-Caustic electrolyte

The Aluminum Oxygen Semi-Cell (aluminum) is categorized separately from other fuel cells because although it relies on a chemical reaction to free electrons for electrical power output, its fuel source is actually the cathodic aluminum plate contained within the cell, Figure 4.6. Conceptually there are three variants of the aluminum cell, each utilizing a different form of oxidant. First is the use of pure oxygen, which is currently under development in Canada for submarine applications and in the United States and Canada for autonomous underwater vehicle (AUV) applications. A second variant uses air as the oxidant and is really a modification to the first. A third variant suggests the use of hydrogen peroxide (H_2O_2) for the oxidant. While unstable in high concentrations, this idea has merit because H_2O_2 provides not only oxygen but also water, a reactant that the cell needs in large quantity.

In the cell pictured in Figure 4.6, a complete system was included to show one of the detriments of the aluminum cell. In this cell, the aluminum anode is literally corroded away to form a product called hydrargillite $\{Al(OH)_3\}$. This product must be constantly removed otherwise it will reduce the conductivity of the electrolyte to the point where the cell will no longer function. This removal

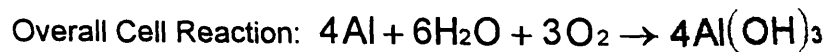
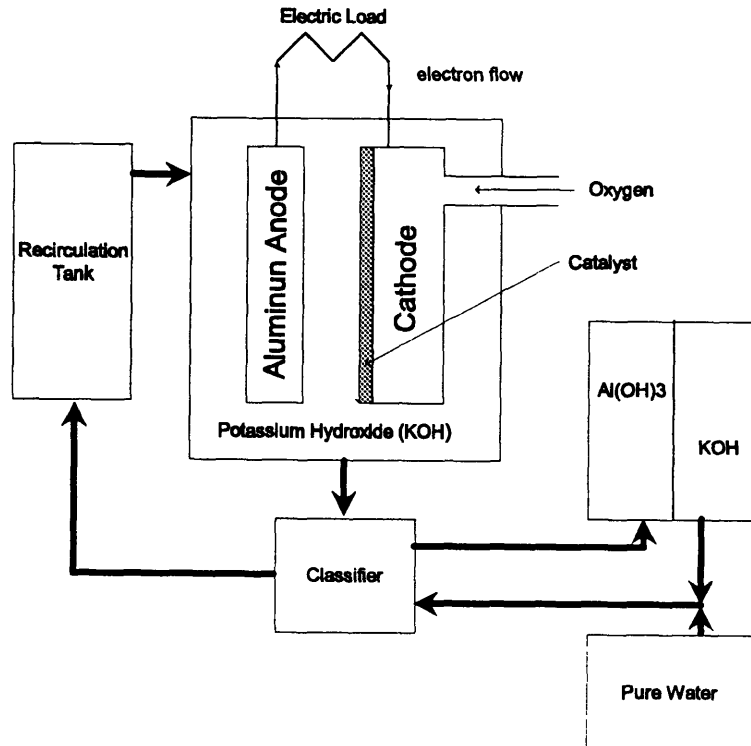

Aluminum Oxygen Semi-Cell [39]

Figure 4.6

process is proposed to be accomplished by flushing the electrolyte from the cell and stripping the hydrargillite, storing the precipitate in one of the reactant tanks. To maintain the proper ionic concentrations, makeup tanks of pure water and potassium hydroxide must be included in the system [13]. The purification of the electrolyte is still a developmental issue, although advances in the 44 inch unmanned underwater vehicle (UUV) program sponsored by the Defense Advanced Research Projects Agency (DARPA) indicates that the problem may be solved on a 15 kW power plant scale [24]. This overall system is attractive from a submarine perspective because the potential exists for no overboard product discharge. Also with no overboard product discharge, the net weight

change of mobility for the plant is theoretically zero, with only the weight distribution changing.

The electrolyte described here is the option currently under development in Canada, but other alkaline (sodium hydroxide) or saline solutions (seawater) could be used. The concept that envisioned the use of H_2O_2 as an oxidant was actually in combination with seawater. AIP studies conducted in Canada have concluded that aside from the hazards of handling H_2O_2 , the most efficient oxidant option for large submarines is oxygen in liquid form [39].

4.1.3 BATTERIES

Batteries fall into two categories, Primary and Secondary. Primary batteries are just that, a primary power source for an application. They are not rechargeable and would be appropriate for one time applications where it is important to keep costs down, i.e. not for frequent replacement over the thirty year life of a ship. Secondary batteries, such as the common lead acid battery, are rechargeable, and have been used successfully in submarines for many years. The battery is a temporary energy storage source intended to provide submerged power for diesel submarines and emergency power in nuclear submarines. Only secondary batteries will be considered in this thesis.

Table 4.2 presents a summary of current and near term secondary batteries. Those technologies which are mature or have immediate promise will be discussed here.

Table 4.2

Summary of Battery Types [15]

Classification	Lead-Acid	Alkaline	Alkaline	High Temperature
Battery Type	Lead Acid	Ni/Cd	Ag/Zn	LAIS
Maturity	Mature	Mature	Mature	Near Maturity
Energy Density (Wh/kg)	20-35	20-37	90	160-225
Power Density (kW/kg)	0.02-0.175	0.1-0.6	0.2-0.4	0.19-0.36
Cycle Life (no. of cycles)	200-2000	500-2000	100-2000	1000
Service Life (years)	3-10	5-10	3	?
Battery Effluent	H ₂ Gas	None	None	None
Ease of Operation	Good, requires frequent monitoring	Very good	Poor, strict operating requirement	Projected to be maintenance free

4.1.3.1 LEAD ACID BATTERIES

Advantages	Disadvantages
<ul style="list-style-type: none"> -Proven technology -Long cell life -Recent improvements 	<ul style="list-style-type: none"> -Least energy dense -Evolves hydrogen while charging -Requires frequent monitoring

By far, the most common battery type in use is the lead acid battery, shown in Figure 4.7. A single cell consists of a series of negative and positive plates, made of lead and lead dioxide respectively, immersed in a sulfuric acid electrolyte and sealed in a rubber jar. Charging and discharging of the cells transfers electrons back and forth between the plates and the electrolyte. The cell voltage is nominally 2 VDC and any number of cells can be connected in series or parallel to provide the required output voltage for the battery group. Connected directly to a DC distribution bus, the instantaneous voltage can be expected to decrease as much as 20 percent depending on the state of charge of the battery [63]. While the basic cell hasn't changed with time, the addition of certain metals to the active cell matrix have significantly improved battery performance [42].

Because the chemical reaction can proceed in both directions, the battery's ability to deliver and receive a total amount of energy depends on the rate of the reaction. In general, when power is drawn from the battery at a low rate, battery voltage will remain high for a longer period of time and more energy can be extracted, Figure 4.8. Battery cooling systems are fitted in some cell designs to dissipate the heat generated by exothermic charging and discharging reactions and internal cell resistance. Cell air agitation systems are also critical to battery performance by keeping the electrolyte thoroughly mixed.

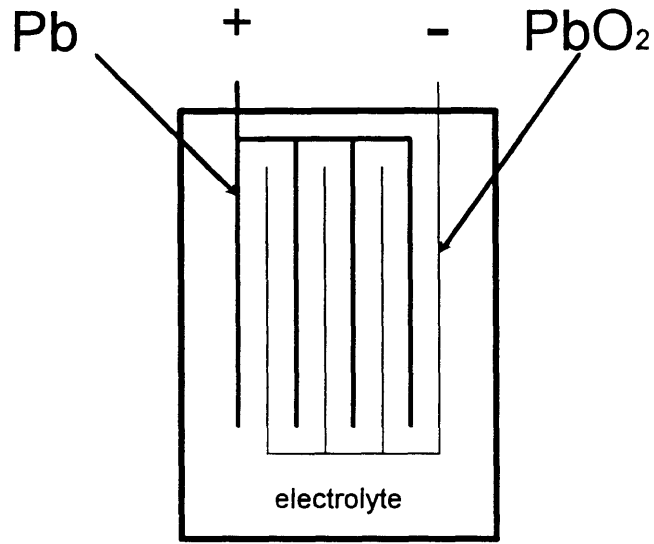

Overall Reaction

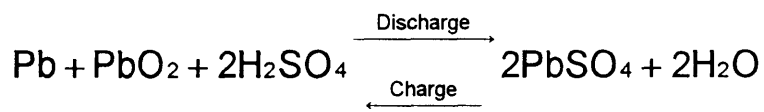

Lead Acid Battery Schematic

Figure 4.7

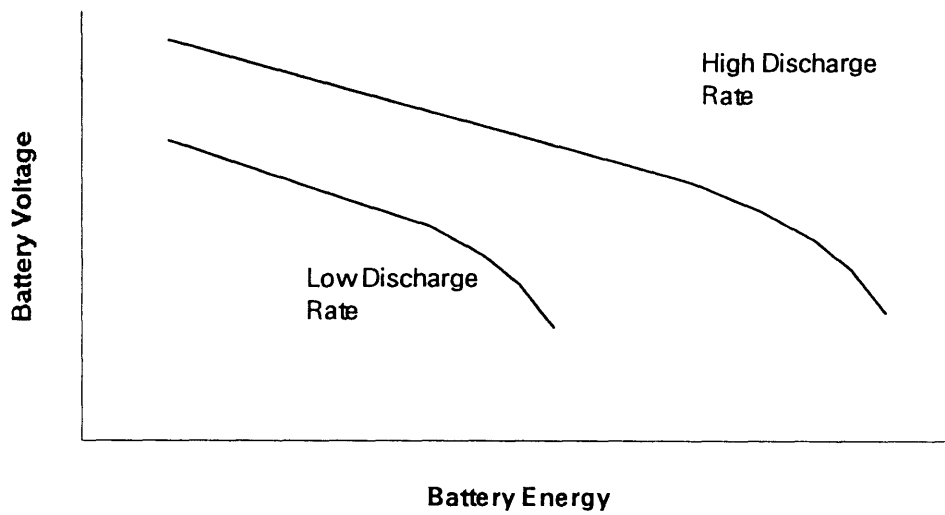

Typical Lead Acid Discharge Characteristic [41]

Figure 4.8

Lead acid batteries require frequent monitoring and careful operation. Hydrogen gas is evolved during all phases of battery operation and is especially high during periods of charge and heavy discharge. As a result, air flow through the battery is closely controlled, Figure 3.9. While charging on the diesel engine, the battery ventilation exhaust is directed directly to the diesel intake to burn any hydrogen produced. Nuclear submarines (and now AIP submarines) can charge their batteries while submerged and must rely on CO-H₂ burners to catalytically convert the hydrogen gas at an electrical penalty of about 9 kW. Catalytic conversion units installed in the battery compartment have been developed to handle normal hydrogen gas evolution [42].

Current AIP systems provide for continuous low power operation at speeds up to 8-10 knots. Any high speed "burst" capability is provided by the storage battery and is a key parameter for battery sizing. Typical AIP battery installations involve 400-500 cells, with each cell requiring frequent monitoring for safety and overall battery performance. As a part of lead acid battery improvement, sophisticated battery monitoring systems have been developed which can provide an instantaneous readout of individual cell parameters and the state of charge of the battery [14].

Specific details of lead acid batteries are contained in Appendix A.

4.1.3.2 NICKEL-CADMIUM BATTERIES

Advantages	Disadvantages
<ul style="list-style-type: none"> -High energy density compared to lead acid -Longer cell life compared to lead acid -Rapid charging -Reduced maintenance 	<ul style="list-style-type: none"> -Unproven at sea -Abrupt cut-off when fully discharged -Memory effects -Expensive relative to lead acid

Nickel-Cadmium (Ni/Cd) battery technology is well established for commercial use, but in sizes much smaller than that required for submarine applications. Virtually any portable rechargeable electric tool or appliance is powered by Ni/Cd batteries. No Ni/Cd battery systems have been installed in a full sized submarine.

The Ni/Cd battery is schematically similar to the lead acid battery in Figure 4.7, with positive nickel hydroxide plates and negative cadmium plates in a potassium hydroxide electrolyte, transferring energy according to the following equation:

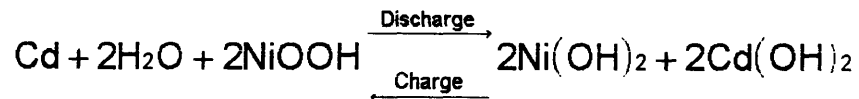

The cells can either be vented or not, releasing gasses developed by electrolysis of the electrolyte [25].

Ni/Cd batteries are attractive from the perspective of their higher energy density. Compared to an equivalent lead acid battery capable of 800 kW of delivered power, Ni/Cd batteries are lighter and smaller [4]:

	<u>Lead Acid (800 kW)</u>	<u>Ni/Cd (800 kW)</u>
Weight (tons):	48.8	26.7
Volume (ft ³):	520	390

The voltage characteristic of the Ni/Cd battery is different than that of the lead acid battery. Illustrated in Figure 4.9, the Ni/Cd battery will maintain a fairly

constant voltage output over its period of discharge, but drops abruptly at the end of its capacity. Included on the chart is a comparison to the lead acid whose operating characteristic might be considered more acceptable to operators because of the more gradual decline in performance near the end of the discharge period. The relative output voltage of each cell can also be seen. Despite its lower voltage, which would require more cells for a given output voltage, the higher energy density of the Ni/Cd battery more than offsets this difference.

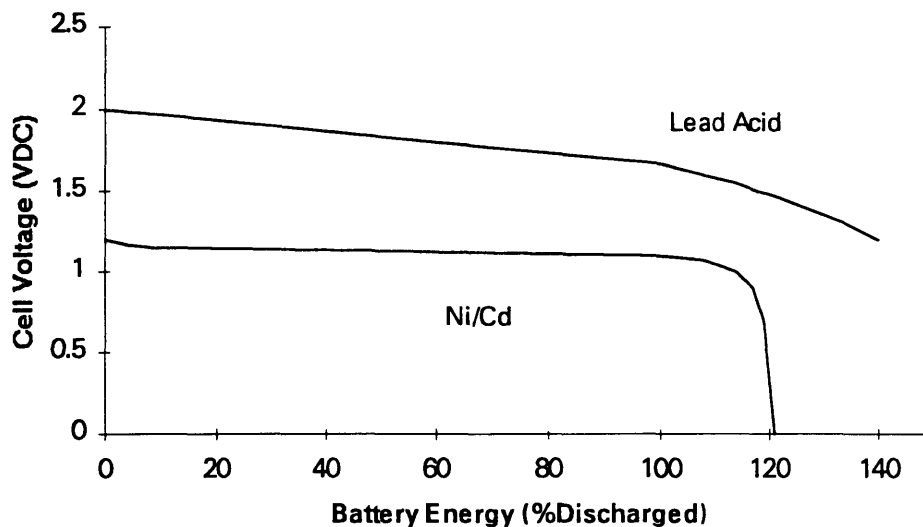

Nickel-Cadmium Discharge Characteristic (with Lead Acid Superimposed) [25, 63]

Figure 4.9

4.1.3.3 SILVER-ZINC BATTERIES

Advantages	Disadvantages
<ul style="list-style-type: none"> -High energy density compared to lead acid and Ni/Cd batteries -Rapid charging -Reduced maintenance 	<ul style="list-style-type: none"> -Prone to internal short circuits -High heat generation

Silver Zinc (Ag/Zn) batteries have proven service in submersibles, but not in full size submarines. Ag/Zn batteries have a high energy density and are a primary power source in special purpose submarines, such as Deep Submergence Rescue Vehicles (DSRVs), and as a backup power source in the nuclear research submarine NR-1. Classified as an alkaline battery, Ag/Zn batteries utilize a potassium hydroxide electrolyte and a sandwich of negative and positive plates made from zinc oxide and sintered silver powder to produce and store electrical power according to the following reaction:

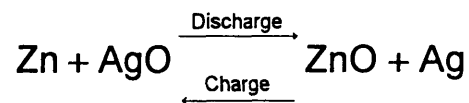

To their credit, Ag/Zn batteries have excellent energy densities, approximately three times greater than lead acid or Ni/Cd [15]. The battery efficiency, or ability to withdraw the total energy stored in the battery is between 95 and 100 percent, compared to a maximum of 90 percent for other batteries. Operating procedures to maintain this type of battery properly are more demanding than for the lead acid battery, and there are additional concerns for excessive heat generation during charging. Add to this reliability problems with zinc dendrite growth from the negative plates into the plate separators and the battery becomes limited in its applicability to the deep cycling routine of a diesel electric or AIP operating cycle. Figure 4.10 illustrates the distinctive discharge characteristic of the Ag/Zn battery [15].

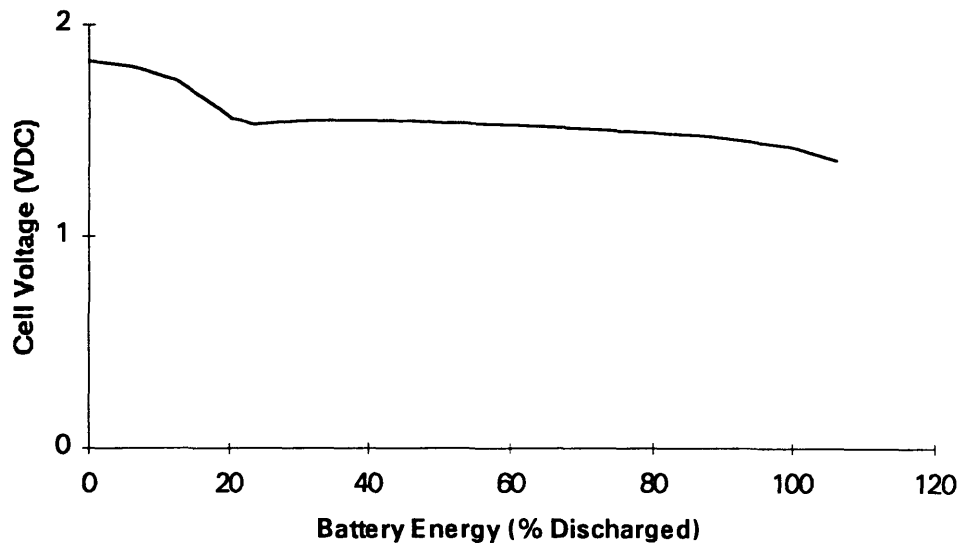

Silver Zinc Discharge Characteristics

Figure 4.10

4.1.3.4 LITHIUM-ALUMINUM / IRON SULFIDE

Advantages	Disadvantages
<ul style="list-style-type: none"> -High energy density compared to lead acid and Ni/Cd batteries -Rapid charging -Reduced maintenance -High energy efficiency 	<ul style="list-style-type: none"> -Not mature technology -High operating temperatures -Battery must be heated before operating

The Lithium-Aluminum / Iron Sulfide (LAIS) battery is the most promising of several high temperature storage batteries currently under development. The United Kingdom has a strong research program underway to develop a reliable replacement system for the standard lead acid batteries in their diesel electric

and nuclear powered submarines. The goal of this project is to produce a battery that is a significant improvement in terms of energy density, but which has a minimum impact on existing shipboard arrangements and logistics.

The arrangement of positive iron sulfide and negative lithium-aluminum is similar to other battery designs, however the electrolyte is a molten salt which must be kept at temperatures on the order of 850°F to prevent it from freezing. Power is transferred to and from the battery according to the following chemical reaction:

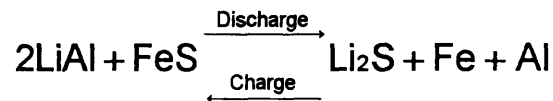

Because the battery operates at such a high temperature, it must be heated initially to melt the electrolyte. Once placed in operation, frequent charging and discharging of the battery will generate enough heat to maintain the molten electrolyte as long as the battery is well insulated. While the LAIS battery has a lower voltage per cell at 1.3 VDC, its discharge characteristic is not unlike the lead acid battery, Figure 4.11. Each cell is completely sealed so despite its high operating temperature the cell is projected to be safe for submarine operations. With an advertised efficiency in extracting energy for use of almost 100 percent, the fully mature LAIS battery should be a contender for replacement of the lead acid battery.

Details on the LAIS battery are contained in Appendix A.

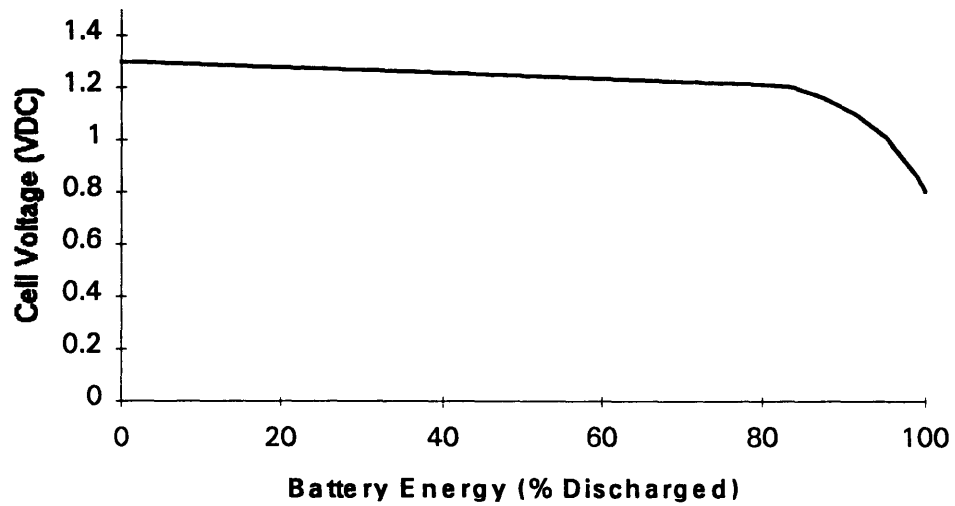

LAIS Battery Discharge Characteristics

Figure 4.11

4.2 MECHANICAL POWER SOURCES

Table 4.3 summarizes the mechanical power concepts to be investigated.

4.2.1 CLOSED CYCLE ENGINES

4.2.1.1 CLOSED CYCLE DIESEL

Advantages	Disadvantages
<ul style="list-style-type: none"> -New application of proven technology -Uses "off the shelf" components -Common fuel source -"Low" cost relative to emerging technology 	<ul style="list-style-type: none"> -Noise -Exhaust management -Cycle gas contamination / corrosion

Table 4.3
Mechanical AIP Concepts

Power Sources (Mechanical)	Remarks
Closed Cycle Diesel	Mature, lowest cost system
Stirling Engines	Mature, low power only
Closed Brayton Cycles	Excellent potential for development
Rankine Cycles	Proven technology
Small Nuclear Power	Under development
Walter Cycles	Safety of H ₂ O ₂

By far the most popular mechanical source among nations investigating AIP is the closed cycle diesel (CCD) engine. Investigated as a possible method to improve underwater endurance as early as 1901, this technology is based on the adaptation of proven diesel engines to the underwater operating environment, and is currently being pursued either singly or in partnerships by Italy, the United Kingdom, Germany, the Netherlands and others [52]. The former Soviet Union is believed to have the most experience with a combatant CCD submarine, the BELUGA, although few details are known [65]. To date, most systems demonstrated at sea are for commercial or research purposes at up to 600 kW. The CCD system can operate either closed or open cycle with air from the atmosphere since it is based on standard diesel engine. Figure 4.12 illustrates the CCD concept. Focusing on the air intake and exhaust system in the closed cycle mode, engine exhaust gasses are cooled and passed through an absorber unit where they are sprayed with low pressure seawater to absorb the CO₂ in the mixture. The resultant mixture is then replenished with oxygen

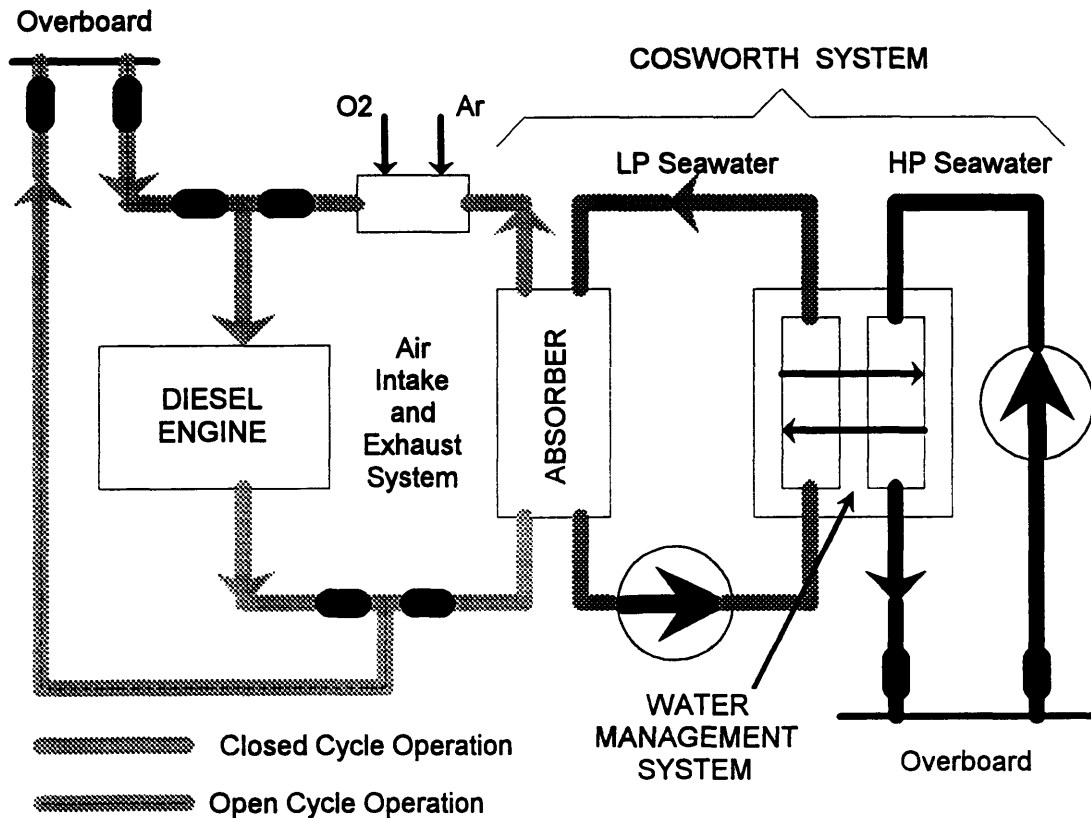

Closed Cycle Diesel with Exhaust Management System [54]

Figure 4.12

and an inert gas such as argon and returned to the engine intake to repeat the cycle. The Cosworth exhaust management system (developed by Cosworth Engineering, UK) consists of a high and low pressure seawater loop and is discussed further in Section 5.3. At sea test results by a German CCD consortium headed by Thyssen Nordseewere showed that the CCD suffers a 5 percent increase in fuel consumption and a 15 percent loss in brake power to overcome the effects of discharging CO_2 at pressures other than atmospheric [8].

The introduction of makeup gasses such as oxygen and argon are important for several reasons. Oxygen is obvious, for without it the engine could not sustain combustion. As for argon or other inert gas, this makeup volume is important to replace the CO₂, water and other gases stripped in the absorber unit. CO₂ is a triatomic gas with a low ratio of specific heats (γ). Studies have shown that by leaving CO₂ alone as the makeup gas, γ for the engine atmosphere would be too low, reducing the pressure rise during compression needed to sustain combustion, forcing physical changes in the engine increasing the compression ratio beyond acceptable limits [50]. The long term effects of sulfuric acid and other contaminants in the atmosphere are also of significant concern. Studies to determine the appropriate synthetic atmosphere composition continue.

Details of a typical CCD system are contained in Appendix A.

4.2.1.2 CLOSED BRAYTON CYCLE

Advantages	Disadvantages
<ul style="list-style-type: none"> -Strong technical base -Quiet signature (high frequency) -Low power compact engine demonstrated -High power density -Variety of fuel sources 	<ul style="list-style-type: none"> -Immature as a closed cycle -Combustion product management -High temperature corrosion problems in direct combustion applications

The Closed Brayton Cycle (CBC) is an AIP application of the basic gas turbine engine. While the concept is plausible and interest has been expressed in developing such a system by several countries, including the United States as a possible replacement for emergency diesel engines on nuclear submarines,

other, more mature technologies such as the closed cycle diesel and Stirling engines have so far limited development of the CBC engine [65].

Several papers have been presented on the specifics of the CBC, scaling parameters from proven low power designs from other applications. One compact concept designed for UUV and submarine applications is shown in Figure 4.13, with the gas cycle in Figure 4.14. The system, classified as indirect combustion, consists of two cycles, a working gas cycle at high pressure with a monatomic gas (Helium, Xenon, etc.) operating between a turbine and compressor through a recuperator, and a combustion cycle transferring the heat of combustion through a heat exchanger to the working fluid cycle. Cycle efficiency for this system is claimed to potentially exceed 50 percent [26].

Another possible design could be a direct combustion cycle utilizing a synthetic atmosphere similar to that described for the CCD, however such a system would bring with it high temperature corrosion problems [58].

Additional details on CBC are contained in Appendix A.

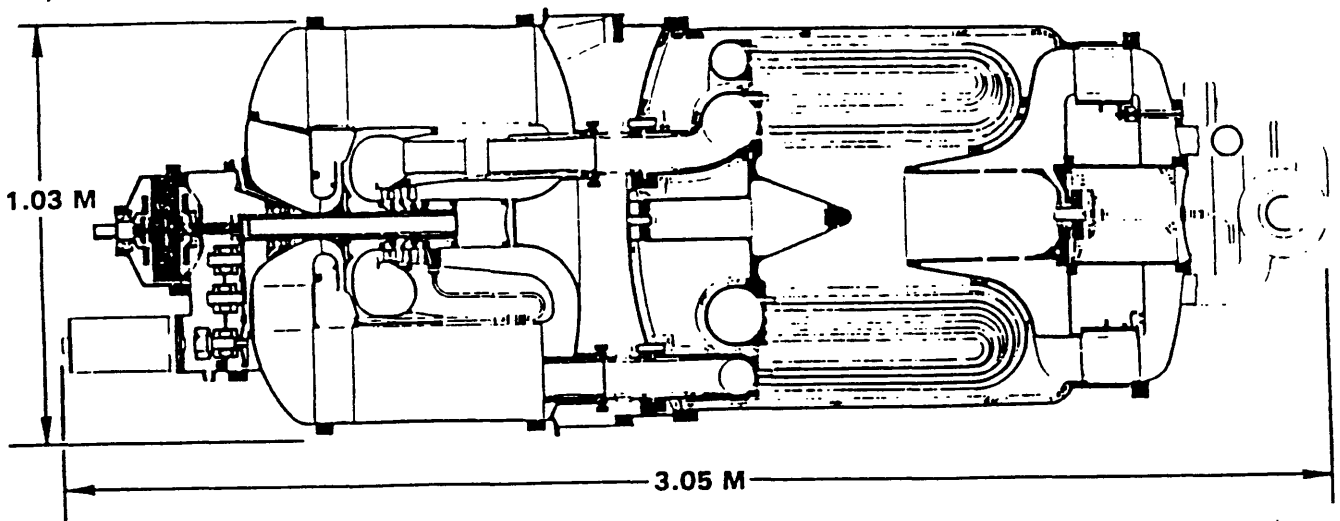

Closed Brayton Cycle Combustion Power System [58]

Figure 4.13

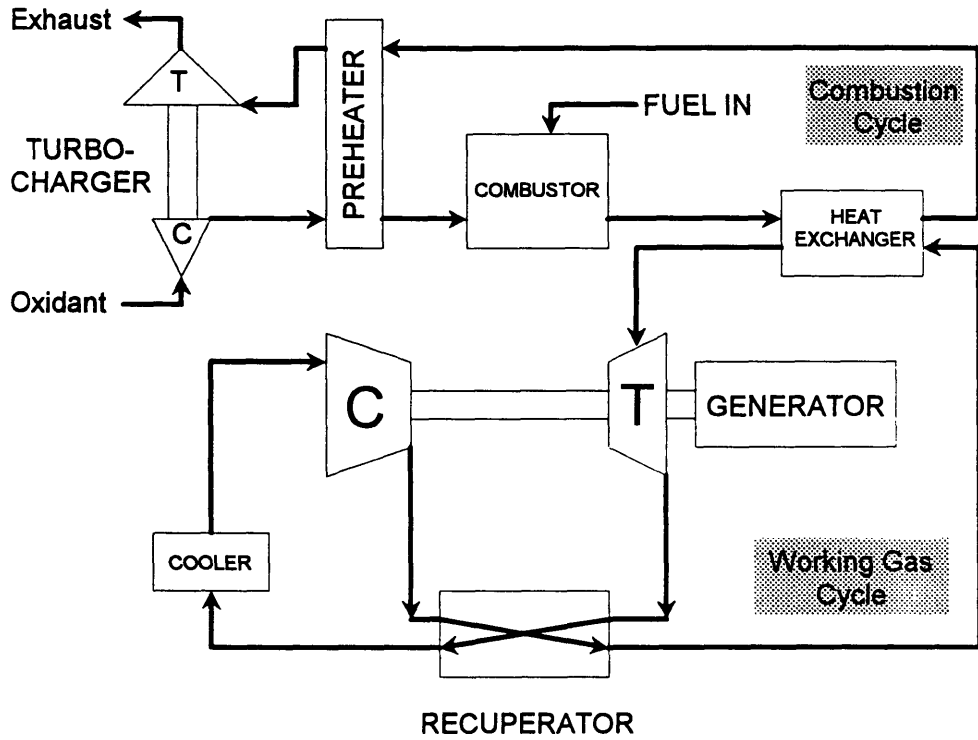

Closed Brayton Cycle Schematic Flow Diagram [58]

Figure 4.14

4.2.2 STIRLING ENGINE

Advantages	Disadvantages
<ul style="list-style-type: none"> -Proven by Sweden at sea -Common fuel source -Adaptable as a bottoming cycle -Low vibration compared to CCD -Reliable operating profile -High Efficiency 	<ul style="list-style-type: none"> -Noise -Exhaust management -High temperature corrosion -Complicated -Presently limited in size

The Stirling engine is an established heat engine concept that has recently and successfully been applied to service in submarines. The Swedish government has operated a 150 kW Stirling AIP power system at sea in

NACKEN since 1988 [30]. Developed by Kockums Marine AB of Sweden, the Stirling plant is one of two plants being considered by the Royal Australian Navy for introduction to their new COLLINS class submarine.

The Stirling engine, whose basic operating cycle is illustrated in Figure 4.15, is an external combustion engine, and can utilize any heat source to power the engine (the Swedish arrangement uses a form of diesel fuel with liquid oxygen). The working gas is trapped between a hot and cold piston, moving continuously between the hot and cold volume and is continuously heated or cooled. The working gas passes through a regenerator which stores heat when the gas moves from the hot to cold side and gives the heat back when the gas moves the other way. The two pistons are mechanically linked to keep the cylinder volumes properly timed [17].

Although presently limited in power output, Sweden reports the Stirling has performed well in NACKEN because of her low patrol hotel load. The Stirling engine combustion chamber can be operated at high pressure so the issue of overcoming the back pressure of the sea is minimized. This high pressure and temperature leads to corrosion problems and will be of concern as Kockums develops engines of higher power [20].

Details on the Stirling engine can be found in Appendix A.

4.2.3 OTHER POWER CYCLES

This section provides an overview of several other thermal power cycles that are being considered for AIP applications. In performing a concept design of an AIP power plant, these cycles could very well encompass the entire propulsion plant as a mono source rather than the hybrid application evaluated in this thesis. These cycles are not considered in this thesis and are included here for completeness only.

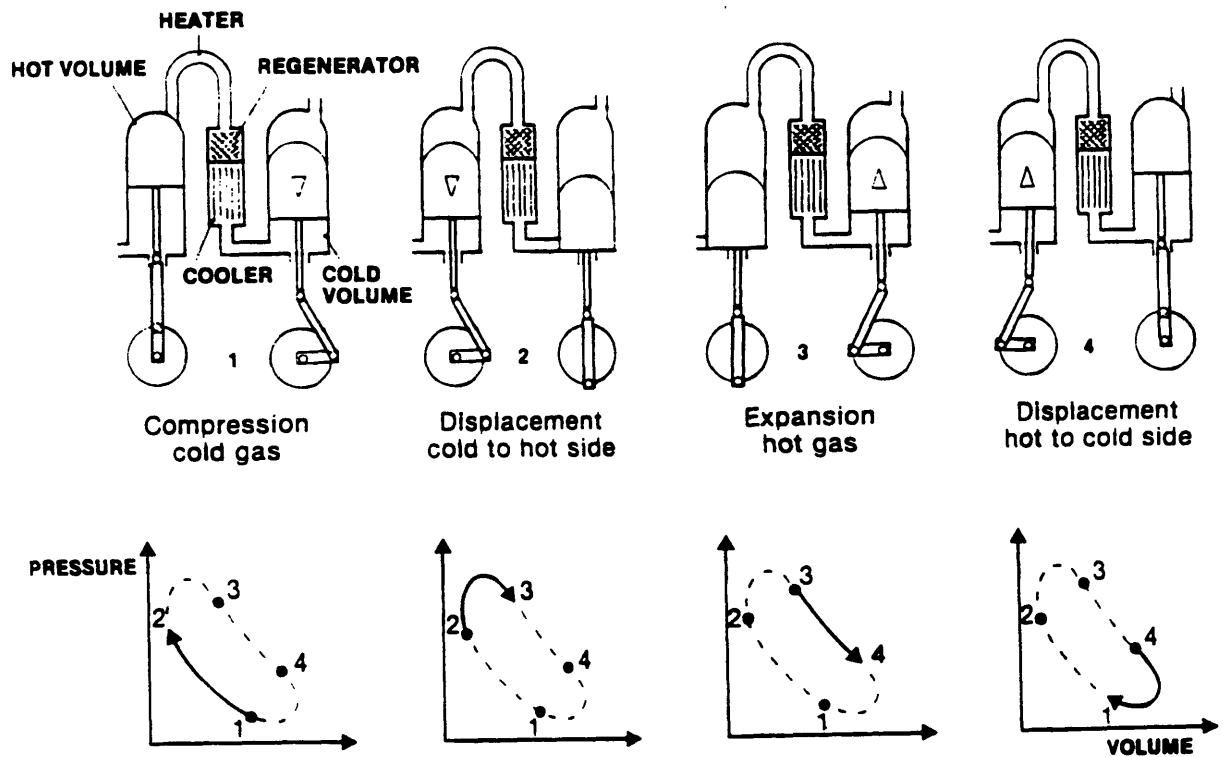

Stirling Operating Cycle

Figure 4.15

4.2.3.1 RANKINE CYCLE

A Rankine cycle is any vapor power cycle which utilizes a constant pressure heat addition to the working fluid, such as the basic steam cycle in a nuclear powered submarine. This principle can be applied as long as an appropriate heat source and working fluid is used. One such application named MESMA (Autonomous Submarine Energy Module) has been developed in France by the Bertin Company under the direction of the French Directorate for Naval Construction for installation in the AM 2000 submarine.

The system is shown in Figure 4.16 and is simply a steam Rankine cycle with a fossil fuel source supplying heat for the steam generator. The combustion

process leads to high temperature corrosion problems similar to those already discussed for CCD and Stirling applications. Bertin proposes that the exhaust gas and water be condensed and stored onboard, with no net change in weight as the fuel is consumed, which would also make the system depth independent. However because of the high pressures at which the combustion cycle could be operated, the exhaust can be discharged overboard [35].

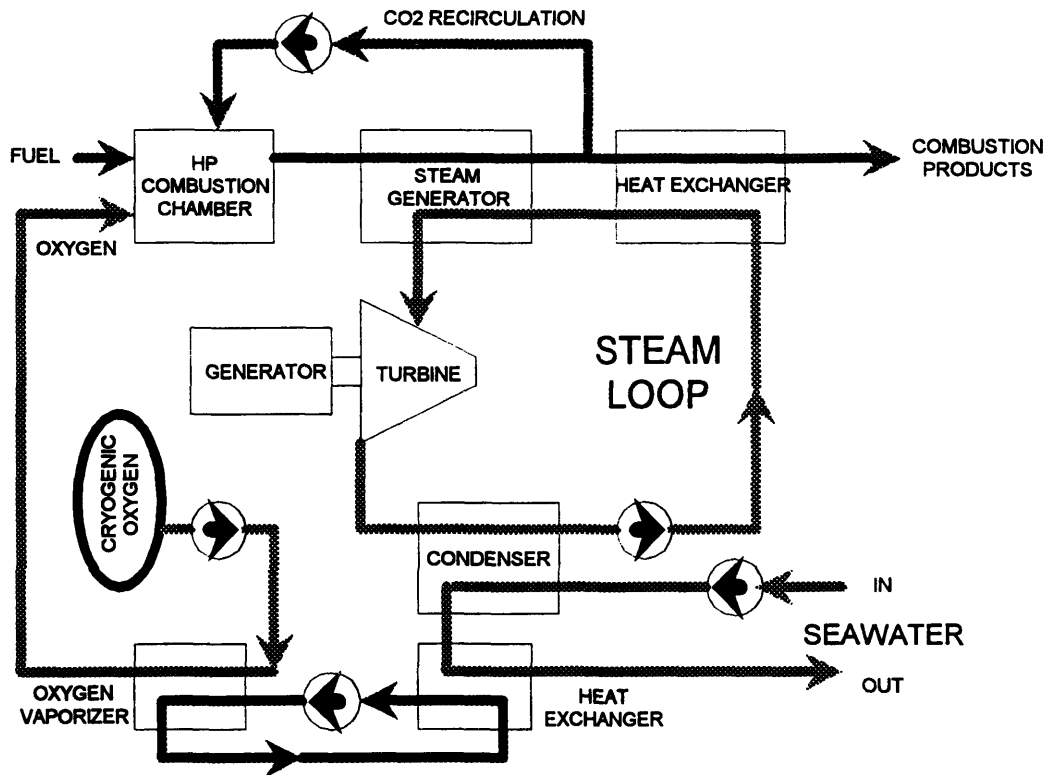

MESMA Operating Cycle

Figure 4.16

4.2.3.2 SMALL NUCLEAR POWER

This AIP option is not simply a scaled down version of a larger nuclear propulsion plant, but rather a low power cycle designed to meet hotel load requirements and recharge batteries while submerged. This system is being developed in Canada by Energy Conversion Systems under the title Autonomous Marine Power Source (AMPS). The obvious contribution of AMPS is that it can provide a conventional submarine with seemingly infinite endurance, but not high sustained speed, at what is hoped to be reduced cost. As with a full sized nuclear power option, the political climate and infrastructure development associated with a nuclear propulsion program may be too great for many countries [29]. Illustrated in Figure 4.17, the AMPS concept features a low power, low temperature pressurized water nuclear power source which is perceived as being safer than a high temperature concept. Heat is transferred to a secondary Rankine cycle where electrical power is produced. Current plans call for a 100 kW plant which could be scaled to 400 kW [23].

4.2.3.3 WALTER CYCLE

The Walter Cycle is a power cycle based on hydrogen peroxide as an oxidizer and is included for a historical perspective since no countries presently show interest in such a power source for submarines, although Sweden employs hydrogen peroxide and diesel fuel for torpedo propulsion [20]. Developed in Germany during World War II, Walter cycle power plants were installed in several experimental submarines, proving their high power density, limited only in their ability to carry reactants. The Germans expected speeds of 24 knots in their Type XXVI submarines while the United Kingdom achieved 26 knot performance for periods of up to three hours in EXPLORER during the 1950's

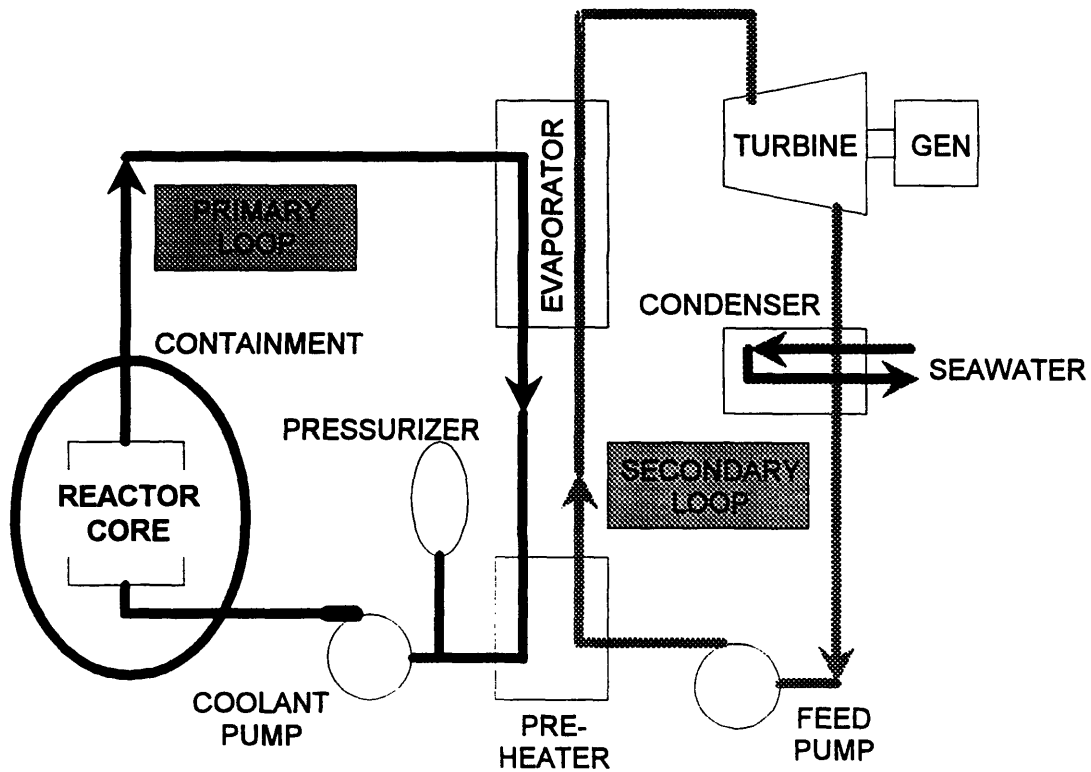

AMPS Power Cycle

Figure 4.17

[43]. The United Kingdom abandoned Walter cycle development with the advent of nuclear propulsion.

Shown in Figure 4.18, the Walter cycle combines diesel fuel and high test (80 percent) peroxide (HTP) to produce a high pressure and temperature mixture of carbon dioxide and steam. HTP is first passed into a catalyst where it decomposes in an exothermic reaction, producing oxygen and water (steam). The oxygen is then passed to a combustion chamber where it is combined with diesel fuel and ignited. Water is also admitted to the combustion chamber to limit the temperature rise and form additional steam. The resultant steam and exhaust product mixture is then directed to a turbine for propulsion power.

Exhaust products are then condensed, the water reclaimed, and the remaining products discharged overboard [23].

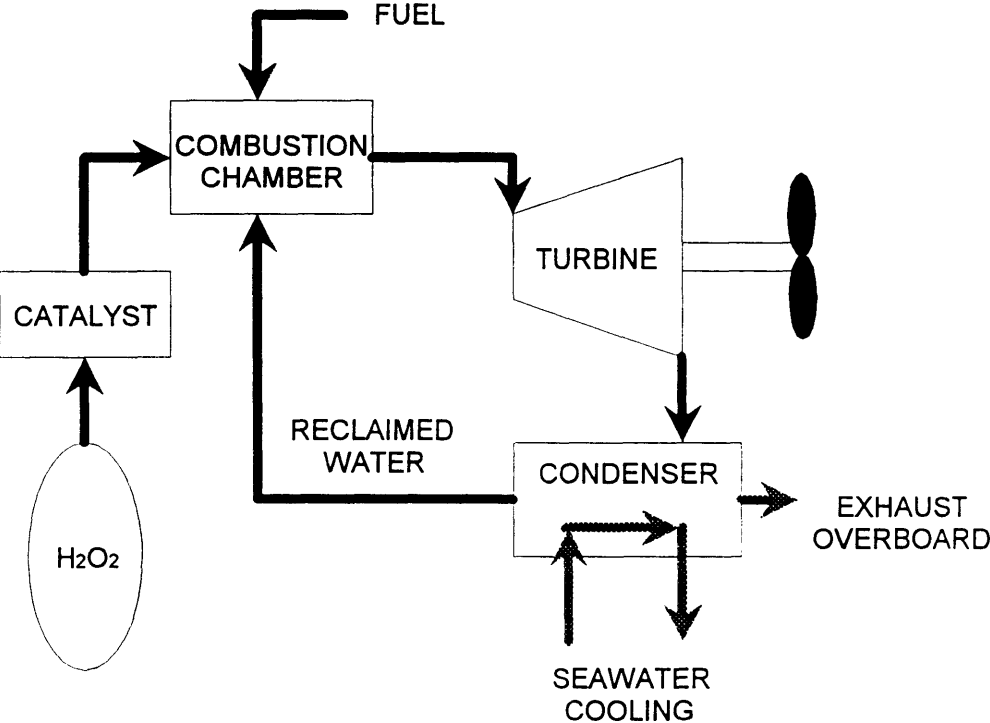

Walter Power Cycle

Figure 4.18

(Blank Reverse)

CHAPTER FIVE

5.0 REACTANTS

This chapter addresses the issue of reactants, which include fuels, oxidants and other fluids or solids necessary to operate any of the power system concepts discussed in Chapter 4. Table 5.1 summarizes the fuels and oxidants to be discussed.

Table 5.1
AIP Reactant Options

Reactants (Fuel)	Remarks
Hydrogen	Pure source, "hard to store"
Hydrocarbon Based Fuels	With reformer-"best" hydrogen source
Reactants (Oxidants)	
Oxygen	Cryogenics best method
Hydrogen Peroxide	Potentially unstable if concentrated
Chemical Reformation	Competitive in some applications

What fuels can be used? Which are the easiest, most weight and volume efficient, and safest to store? These questions have been the subject of much debate in the AIP arena. One such study illustrates the point that the most energy dense fuel may not be the best for AIP applications. Consider the following fuels and oxidants and their energy density:

Fuel <hr style="width: 10%; margin: 0 auto;"/>	Energy content <u>(kW-hr/kg)</u>	Energy storage density (reactant and tankage) <u>(kW-hr/kg)</u>
Uranium-235*	500.0	---
H ₂	34.7	---
H ₂ + O ₂	3.7	0.17
Diesel Fuel	12.7	---
Diesel Fuel + O ₂	2.8	0.47

*included to illustrate the high energy density of nuclear power

From this data, one might conclude that pure hydrogen would be a good choice as a fuel because it is the most energy dense, however when the "cost" of storing the fuel and oxidant is included, which is a metal hydride for hydrogen and cryogenics for oxygen in these cases, the combination of Diesel Fuel + O₂ appears better [51].

This is perhaps the most critical portion of the AIP concept. Chapter 5 is divided into three parts: fuels in Section 5.1, oxidants in Section 5.2, and because it is a significant concern for most power sources the management of the products of combustion will be addressed in Section 5.3.

5.1 FUELS

5.1.1 HYDROGEN

Hydrogen is the basic building block of all fuels, and hydrogen in a pure form as H₂ is required in the internal chemical processes of all fuel cells. Hydrogen can be stored in one of several pure forms or reformed from a hydrogen based fuel as required by the power system.

5.1.1.1 HYDROGEN - GASEOUS STORAGE

Although the storage density for this form is very poor, gaseous storage is used extensively in industry where transportation of small volumes of gas are required. Increasing the gas pressure will allow more H₂ to be stored but will also increase the size and weight of the storage cylinder. A standard high pressure cylinder, 42.5 liters at 6000 psi, would contain only 1.23 kg of H₂ while the cylinder plus H₂ weighs 138.8 kg for a H₂ weight percentage of 0.87 percent. At this high pressure, the energy contained in the compressed gas represents a significant hazard should the tank rupture, thus strong consideration would be given to placing the tank outside the pressure hull. Precautions must also be taken to prevent hydrogen embrittlement of the cylinders though the use of special materials and to ensure the cylinders meet established shock performance standards [57].

5.1.1.2 HYDROGEN - CRYOGENIC STORAGE

Cryogenic storage of any gas as a liquid is more beneficial from the perspective that more of the gas can be carried for a given available volume. But as with gaseous storage, the penalty of this form of storage lies in the extraordinary measures which must be taken to maintain the cryogenic conditions.

Storage of cryogenic liquids has been investigated extensively with super insulated dewars being the accepted form of cryogenic storage. In this scenario, liquid hydrogen (LH) would be loaded at the beginning of a mission, and some boil off accepted due to inevitable heat conduction into the tank. This phenomena is especially critical for LH whose boiling point is 20°K. Accounting for this boil off means that additional hydrogen beyond that for mission requirements must be loaded, plus some method devised to deal with the

vaporized hydrogen gas itself, either by discharge overboard (detection risk) or combustion. One study conducted at Newport News Shipbuilding suggested that a reliquification plant be installed, but this would require electrical power to run the required compressors and equipment, a luxury not found in an AIP submarine [65].

The exceptionally low temperatures bring special considerations associated with the of embrittlement of tanks, the sealing of valves and connections and specially insulated hull penetrations should the tanks be stored outboard of the pressure hull, their most likely location because of safety concerns. In light of these considerations, as with gaseous hydrogen, meeting submarine shock standards will also be a challenge. Also to be considered are the logistics of fueling the ship. While LH can be transported safely, its availability is not as wide spread as other fuels or even liquid oxygen, so replenishment overseas or outside a specific port may prove difficult.

5.1.1.3 HYDROGEN - METAL HYDRIDE

Of the three pure hydrogen storage methods, the Hydrogen-Metal Hydride (hydride) method is the only one than has been tested at sea. An iron titanium hydride storage system was used in Germany in a Type 205 submarine during fuel cell tests in 1987 [29].

The principle of operation for a hydride is that a metal matrix of some form is saturated with hydrogen gas with the hydrogen bonding itself to the matrix. The amount of hydrogen absorbed depends of the temperature and pressure in the matrix, and varies by matrix type [57]. This concept of charging the hydride with an over pressure of gas makes it an easy way to refuel the submarine, and is considered to be the safest of all the hydrogen storage methods. When the hydrogen is required for power generation, a reduction in hydrogen gas pressure

along with heating the matrix in some forms will cause the hydrogen gas to be released for use. This method of hydrogen storage is very volume efficient, but brings with it a significant weight penalty. The weight density (weight of hydrogen to the total storage system weight) for the hydride used in the Type 205 submarine was 1.5 percent and is typical for most known hydrides, although researchers in India have claimed weight densities as high as 6 percent [56, 65]. Other issues involve improving the hydrogen storage density for low temperature hydrides, and the sizing of storage containers which provide the proper amount of heat transfer when required.

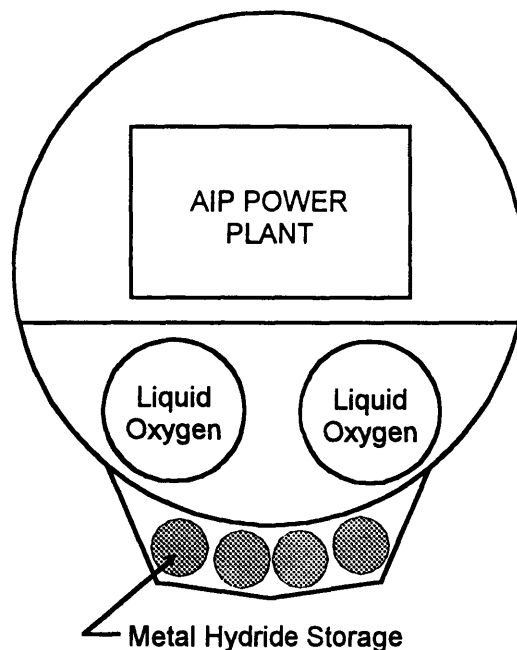

Metal Hydride Storage in Ex-U1 (German Type 205)

Figure 5.1

Because of the tremendous weight associated with the hydride, particular attention has to be given to the placement of this weight on the ship in terms of

buoyancy and stability. Any large weights added should be placed low and will require additional displaced volume to carry the weight, a weight limited design. Some of this weight could be offset by using it in place of "stability lead" in the balancing of the ship. Both of these concerns were addressed in the Type 205 modification as some lead was removed with the hydrides located external to and below the keel, Figure 5.2 [36].

5.1.1.4 HYDROGEN - BY REFORMATION

This method is one of the most popular hydrogen storage options and is being studied carefully by the research community. Having reviewed the weight and volume penalties associated with pure hydrogen storage, not to mention the complexities of the storage methods themselves, the concept of storing some form of hydrogen based fuel and reforming it to a pure hydrogen fuel in situ is very attractive. While the fuel is not pure hydrogen, it is dense enough to overcome this difference, and is in general much easier to handle and store. The decision becomes what fuel to use and how to reform it?

To reform a fuel into hydrogen, steam at high temperature (approximately 800°F) is brought into contact with the fuel causing (for methanol) a reaction similar to :

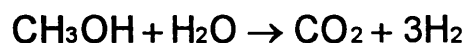

At issue is how to generate the required high temperature for reformation. High temperature fuel cells can conduct the reformation internally, but low temperature fuel cells require that this process be accomplished externally. One possible source of heat comes from burning the tail gas of the reformat itself. Incomplete reformation and impurities in the fuel can lead to the creation of other

gasses, such as carbon monoxide, nitrogen and methane. Of these gasses, carbon monoxide will poison the PEM cell, severely decreasing its power output. The elimination of carbon monoxide is a developmental issue for reformers [3].

Typical candidate fuels for reformation include diesel fuel, methanol and ethanol. Diesel fuel is easy to handle, fully compatible with submarine operations and available world-wide. Reformation methods for diesel fuel have been developed, but extra processes to ensure the elimination of carbon monoxide make this process more cumbersome. Methanol and ethanol can be reformed while minimizing the production of carbon monoxide, with methanol producing more hydrogen gas per mole of fuel [3]. The ethanol reformation process also requires more water, and produces more carbon dioxide which must be disposed of [13]. Methanol is a synthetic fuel that is in ample supply because of its interest as a replacement fuel for automobiles. Methanol however is immiscible in water, requiring it to be stored in its own tank, or in seawater compensated tanks with bladders separating the fuel and water.

One other reformation process has been suggested for AIP applications, and involves the transformation of a hydrocarbon fuel form one form to another, releasing hydrogen gas in the process. A proven technology in the chemical industry, one example fuel to be reformed is cyclohexane,



producing 56 grams of hydrogen per 780 grams of cyclohexane (>7% H₂ by weight) [26].

In summary of the hydrogen storage methods discussed above, Figure 5.2 presents a comparison of the various options. From this graphic it can be seen that while gaseous or cryogenic hydrogen contains 100 percent hydrogen, the percentage weight of hydrogen stored is inferior to that for reformed methanol. Even a metal hydride ($\text{FeTiH}_{1.95}$) stores more hydrogen per cubic meter, however with a hydrogen storage weight percent compared to the storage system of less than 1 percent, it clearly carries a weight penalty.

Additional details on hydrogen storage are contained in Appendix B.

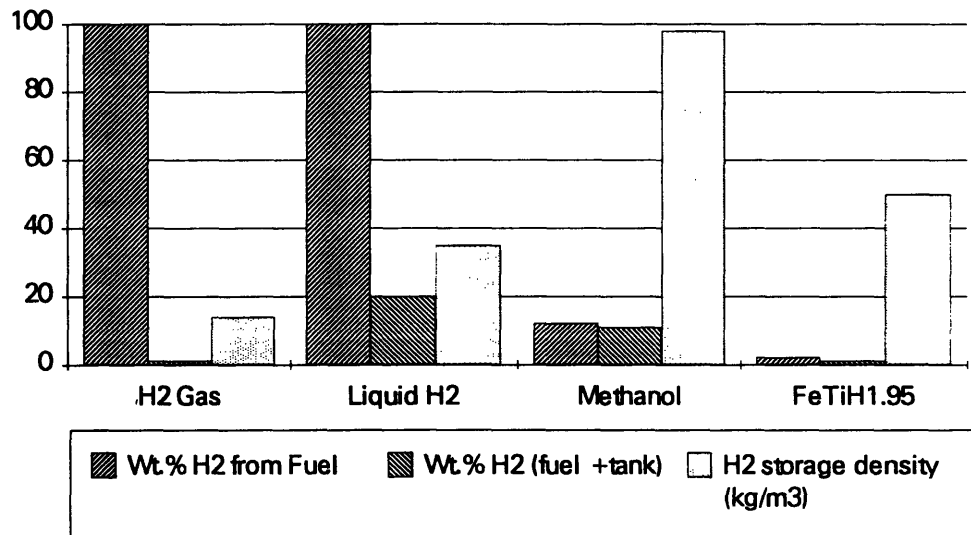

Hydrogen Content of Various Fuels [44]

Figure 5.2

5.1.2 OTHER FUELS

A variety of fuels have been considered for AIP applications. The goal of these fuels can be summarized by saying they should have a high energy density, be easy to handle and be readily available. These fuels should also

produce a minimum amount of exhaust products, so less has to be discharged overboard or stored onboard. Marine diesel fuel is available world wide, but is not an optimum fuel source. As illustrated in Section 5.1.1.3, marine diesel is difficult to reform, and also contains sulfur which can lead to the formation of sulfuric acid and high temperature corrosion problems in synthetic atmosphere engines. Desulfurized diesel fuel is common but not a regular fuel in standard logistic supply systems. The use of JP-5 ($C_{12.7}H_{22.8}$), a standard aviation and gas turbine fuel has been considered in some applications because of its high energy density and logistic availability [70]. The French MESMA system presently uses ethanol although other fuels are being considered, and the Swedish Navy utilizes a sulfur free fuel, "Lacknafta", which is similar to marine turpentine. [20, 35]

5.2 OXIDANTS

5.2.1 OXYGEN

Oxygen is required to complete the combustion process, and can be provided in many different forms.

5.2.1.1 OXYGEN - GASEOUS STORAGE

Arguments similar to hydrogen above can be made against gaseous storage for oxygen when compared to other methods such as cryogenics. Oxygen storage in high pressure flasks is very inefficient in terms of volume and weight. As an example, a study conducted at Newport News Shipbuilding evaluated methods of oxygen storage. In an attempt to store 100MW-hrs of oxygen, 500 - 21 ft³ standard oxygen flasks at 3000 psi were required with a total weight of 475 tons and a volume of 13,400 ft³. A comparable liquid oxygen

system would weigh 109 tons and displace 3348 ft³, illustrating the efficiency of liquid oxygen storage [65].

One novel method of gaseous oxygen storage has been proposed by an Italian company, Fincantieri, employing torroidal gas cylinders which are welded together to form a pressure hull. This method helps to alleviate the weight and volume penalties of gaseous oxygen storage by replacing ship structure with oxygen cylinders. The cylinders are designed to store the oxygen at 4000 psi and also store exhaust products from a CCD engine [66]. This principle is illustrated in Figure 5.3. One obvious concern with this design is that while the individual torroids are no doubt sturdy, can the process of joining these torroids together form a pressure hull that is strong enough to withstand shock and can be adequately inspected for cracks and corrosion.

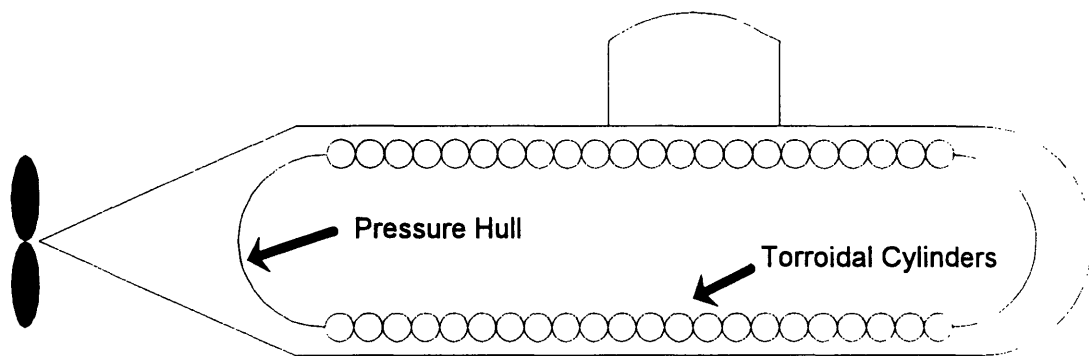

Torroidal Gaseous Oxygen Storage Concept

Figure 5.3

5.2.1.2 OXYGEN - CRYOGENIC STORAGE

This method is considered to be the best option for storage onboard an AIP vessel. More volume efficient than gaseous storage, an extensive

experience base exists for the handling of liquid oxygen (LOX). Storage tanks would be comprised of super insulated dewars, with a typical storage temperature of 90°K (-183°C). Based on typical tank arrangements, the boil off would be approximately one percent of the volume per day [7]. Unlike hydrogen above, this boil off is beneficial with the vaporized oxygen used as breathing oxygen for the crew.

In an effort to reduce the heat absorption of the LOX, large tanks are more efficient, but become more difficult to place on the submarine. There are many safety concerns associated with LOX storage inside the pressure hull to include:

- Failure of tank, flooding the ship with oxygen (oxygen poisoning)
 - Increased fire potential
 - Cryogenic contact with sensitive materials (such as HY steel hull)
- [31].

Sweden has adopted LOX storage for use in NAECKEN and has reported no operational problems to date. Their concept is similar to that pictured in Figure 5.1, with two double insulated LOX tanks contained in an isolated LOX compartment equipped with monitoring equipment and an overboard venting system for emergencies. In this arrangement, all the LOX piping is completely shielded from the crew, much the same as a reactor compartment onboard a nuclear submarine [20]. A study conducted by Johns Hopkins University Applied Physics Laboratory in the 1980's investigated the replacement of oxygen generators with cryogenic oxygen tanks, envisioning a storage system with tanks located in the ballast tanks external to the pressure hull. In this study, placement of the tanks in the corrosive environment of the sea was judged to be

a safer option than standard double insulated tanks located inside the pressure hull in place of the oxygen generators [7].

5.2.1.3 OXYGEN - CHEMICAL REFORMATION

There are a number of chemical compounds which can produce oxygen as a by-product of a chemical reaction. One compound that has found use in the AIP arena is Sodium Perchlorate (NaClO_4), which is used to generate oxygen for the US Navy's Oxygen Breathing Apparatus (OBA) units, and is now proposed as an oxygen source in an aluminum-oxygen power system for the 44 inch UUV. In this concept, Figure 5.4, oxygen candles are contained in a large vessel and ignited sequentially to maintain a certain oxygen pressure in an accumulator, thus supplying oxygen on demand without the issues of oxygen boil off over long periods of inactivity [59].

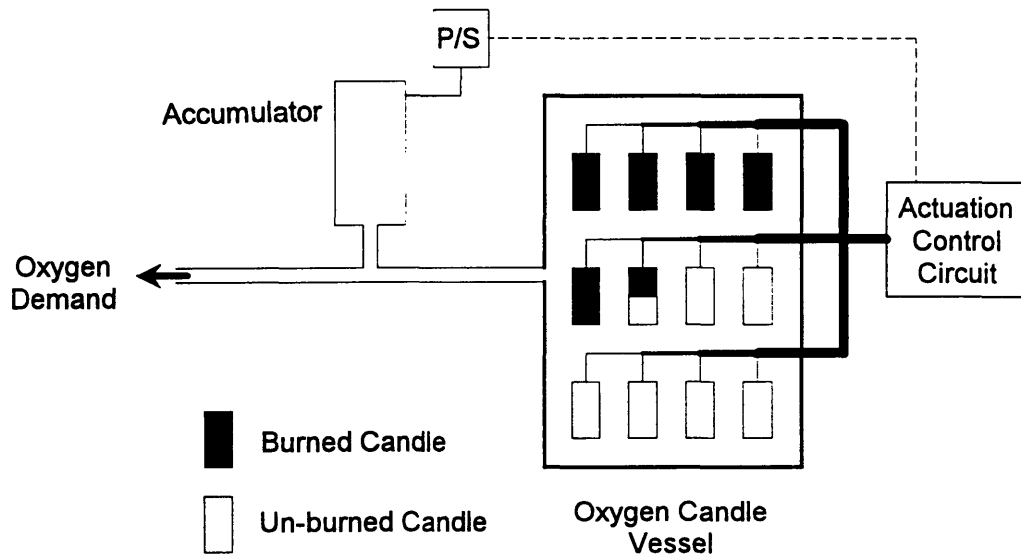

44 Inch UUV Oxygen Supply Concept

Figure 5.4

5.2.1.4 OXYGEN - GENERATION ONBOARD

Generation oxygen onboard submarines is not a new concept as nuclear submarines have been doing this for many years with a "reverse" version of the alkaline fuel cell. An oxygen generator can produce up to 13.4 kg of oxygen per hour while requiring 50 kW of electrical power, Appendix B [7]. For comparison, a standard PEM cell requires approximately 25 kg of oxygen to produce 50 kW of electricity. Based on this simple analysis, Generation of oxygen by electrolysis is not a viable option.

One other onboard generation option is the extraction of oxygen for the ocean itself. Artificial gill technology involves the use of a porous membrane which only passes gas molecules to extract the dissolved oxygen from the sea. Oceans in the northern latitudes possess the required oxygen concentration, greater than 4 ml/l of seawater, necessary for this technology to be successful [1]. The present state of development for this technology renders it as large and bulky, requiring approximately 30 percent of the electricity that its oxygen can produce. Further development may make this technology a viable option for the future.

5.2.2 HIGH TEST HYDROGEN PEROXIDE

Hydrogen Peroxide (H_2O_2) is a versatile compound which has many uses. Common in low strengths as a disinfectant, H_2O_2 in high concentrations is extremely reactive and quite powerful. For this thesis, high test hydrogen peroxide (HTP) is defined to mean H_2O_2 of sufficient concentration to be used as an oxygen source for an AIP vehicle. HTP decomposes by the following reaction:

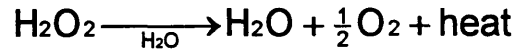

In very high concentrations, i.e. greater than about 75 weight percent H_2O_2 , the chemical reaction is very unstable and dissociation can occur very rapidly in the presence of a catalyst, which can be almost anything. In lower concentrations however, H_2O_2 can be handled successfully. An accepted method for storing H_2O_2 proposed in several studies is to contain the reactant in polyvinyl chloride bladders inside seawater compensated tanks [44]. A 70 percent H_2O_2 solution can be expected to yield 33 percent oxygen by weight.

In summary of the oxidant storage methods discussed above, Figure 5.5 compares the weights and volumes of the various sources [44].

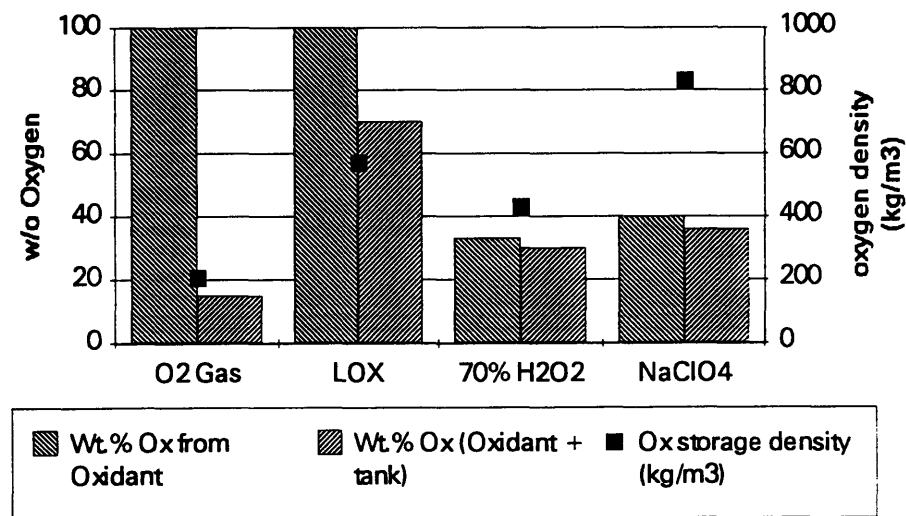

Comparison of Oxidant Storage Methods

Figure 5.5

5.3 WASTE PRODUCT MANAGEMENT

Almost as much of an issue as what fuels to use is how to deal with the waste products of AIP. From a design view, management of the waste products affects the net power output of the plant since energy will be required to return the products to the sea or process them for retention onboard. Operationally, exhaust products may leave a trail that while invisible to the eye, could be detected by other sophisticated means.

Since energy conversion generally involves hydrogen consumption, any fuel that brings with it other elements such as carbon will have waste products to be processed, such as carbon dioxide. Some waste products are not really waste like the pure water generated from the PEM cell which is potable and can be easily stored for crew consumption or transferred to a variable ballast system for discharge overboard. The aluminum-oxygen cell generates hydrargillite, but as water and potassium hydroxide are added to the system to compensate for the corrosion of the aluminum plates, this waste can be stored in the empty reactant tanks for processing upon return to port. Thus the primary concern of waste management is how to deal with carbon dioxide and other inert gasses.

In the torroidal oxygen storage design by Fincantieri of Italy, the concept proposes compression and storage of the waste gas without discharging overboard [29]. The other alternative is to discharge the gasses overboard. After expending the energy to compress the gas to operating depth pressure (20 kW, based on PEM cell with reformed methanol at 500 kW and 1000 ft operating depth, Appendix B), the gas must be diffused so that large bubbles don't trail the submarine. One concept for distributing the gasses is shown in Figure 5.6 [22].

The most promising solution to the carbon dioxide discharge problem comes from a consortium headed by Cosworth Engineering of the United Kingdom. In this (Cosworth) system, exhaust gasses are scrubbed of carbon

dioxide, which is soluble in water, by passing the gas through an absorber unit where it is sprayed with low pressure seawater until the water is saturated. The carbon dioxide saturated water is pumped to a water transfer unit where spools connecting a high pressure (submergence pressure) loop and the low pressure scrubbing loop are swapped. The saturated water is then flushed to sea via the high pressure loop. The system is effective, quiet, and has been demonstrated successfully at sea. The system claims to minimize the power required to discharge carbon dioxide overboard because the seawater pumps work only against the differential pressure in their loop instead of against full sea pressure,

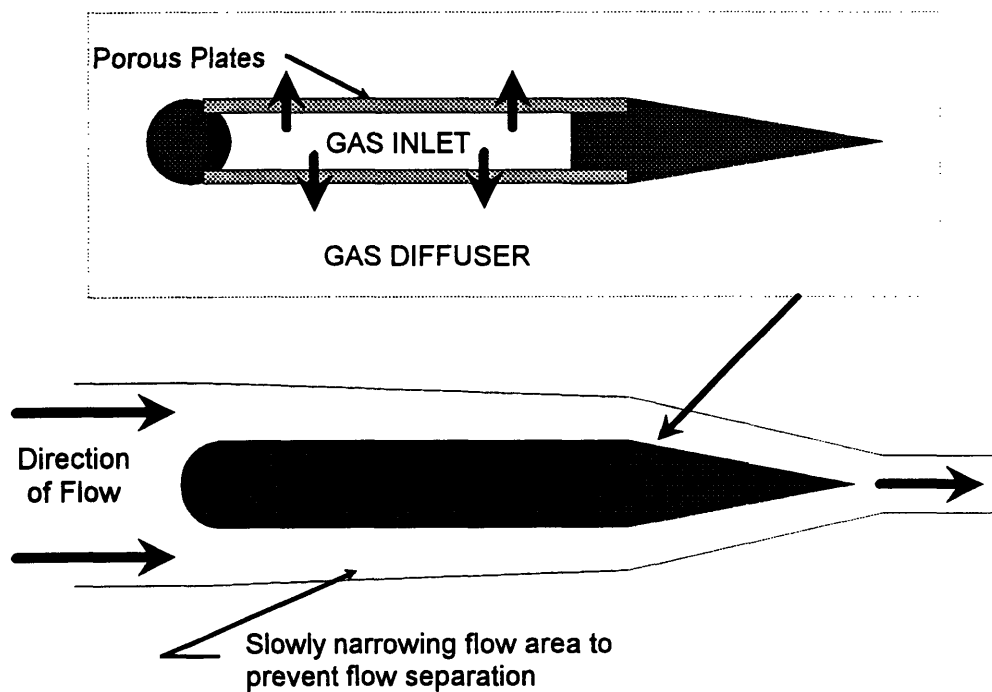

Liquid / Gas Flow Mixer

Figure 5.6

requiring only 6 percent of the output power of the plant [65]. Using this estimate, about 30 kW of power would be required to discharge carbon dioxide overboard from a 500 kW PEM plant with reformed methanol.

The Cosworth system is being strongly considered by almost every nation interested in processing carbon dioxide gas overboard.

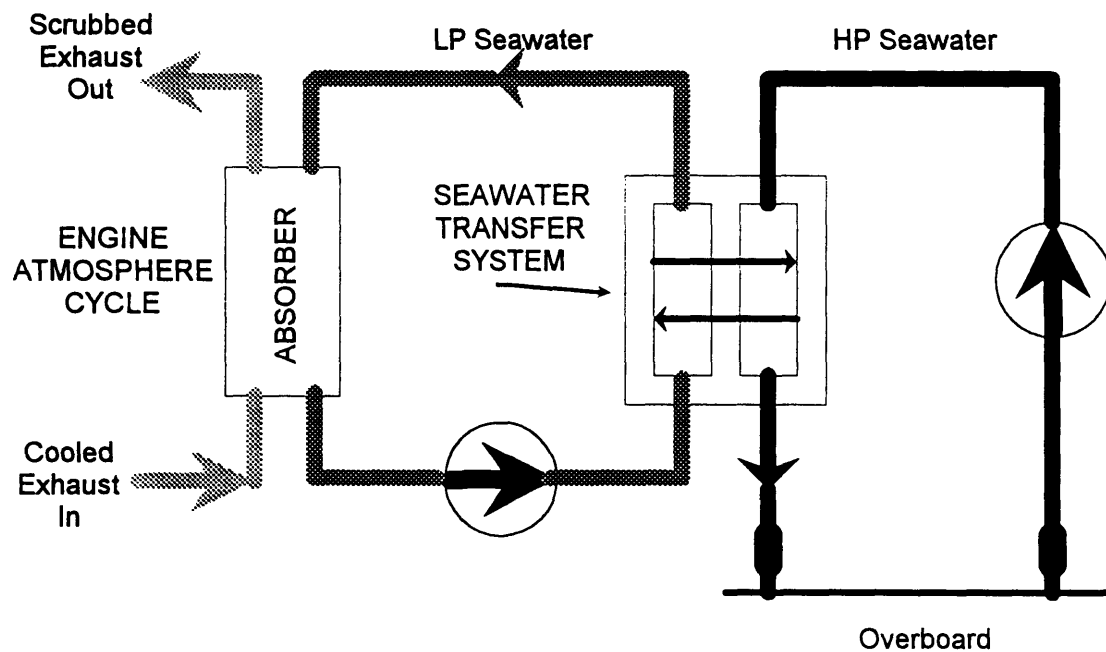

Cosworth Exhaust Management System

Figure 5.7

(Blank Reverse)

CHAPTER SIX

6.0 THE SUBMARINE MODEL

The modeling process for the weights and volumes which determine the shape of the final submarine hull are described in this chapter. Section 6.1 describes the submarine envelope, while Sections 6.2 and 6.3 describe the model for volumes and weights. Section 6.4 outlines the method for ship powering and endurance calculations.

As stated in Chapter 2, the estimation of weights and volumes for a submarine concept design come from an extensive historical data base. For this thesis, the data base for weights and volumes is derived from a 1988 Massachusetts Institute of Technology (MIT) thesis by Stenard titled "Comparative Naval Architecture of Modern Foreign Submarines" [61]. The approach for the model is based on the MIT Math Model for Conventional Submarines [53] (MIT Math Model) and several papers by Captain Jackson on submarine parametrics and concept design [33, 34].

The AIP submarine model builds from a baseline diesel electric submarine, which was originally synthesized using the MIT Math Model [68]. In this design, a concept submarine, Appendix C, was developed using the math model and balanced in sufficient detail to gain confidence in the model, evaluate the validity of the various coefficients, and establish certain weights and volumes for use in this thesis. This model therefore develops a "Hybrid" submarine, one that retains full diesel electric capability and adds an AIP option, rather than one that relies on AIP alone.

6.1 HULL ENVELOPE

It is well accepted that a streamlined form will offer less resistance to flow than one that is irregular in shape. Because the modern submarine is optimized to operate below the water surface rather than above as in pre-1960 designs, the body of revolution or "Albacore" form has been adopted as the primary hull shape. In describing its shape, Jackson states that an optimum design will have "a well rounded nose and a streamlined tail with an L/D (length to diameter) ratio of about 6 and a maximum diameter about 40% aft of the forward end" [33].

It is seldom possible to achieve an optimum shape as the size of the hull envelope is driven by the weight and volume of the equipment contained inside the submarine and usually results in the addition of a section of hull, constant in diameter, between the forward and after parabolic sections, Figure 6.1. The

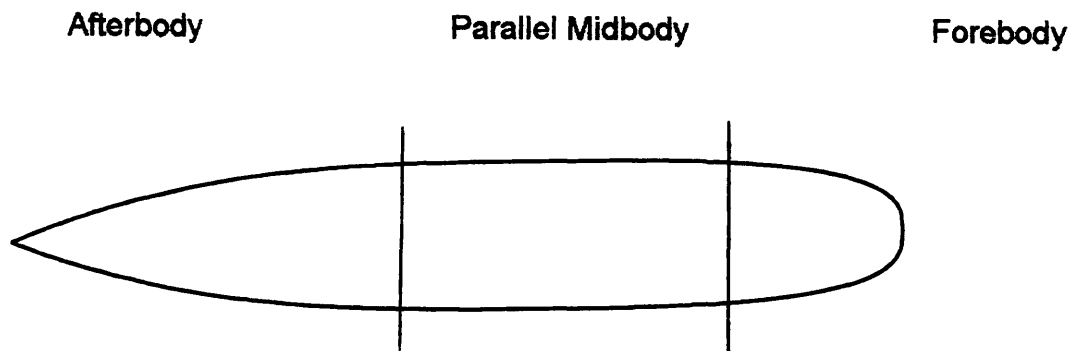

The Submarine Envelope

Figure 6.1

diameter is generally constrained by navigational restrictions imposed on the beam and draft by the harbors where the ship is expected to operate. Thus an envelope balance must be achieved which contains sufficient volume for the ship, does not pose too wide a beam and is an acceptable compromise with regards to L/D ratio. In addition to changing the length or diameter, the hull shape can be made fuller or sleeker by varying certain constants which describe the parabolas making up the bodies of revolution and can be used to adjust the buoyancy contributed by the hull. Appendix D contains details of the hull envelope model.

6.2 VOLUME ESTIMATES

The details of the volume estimates are contained in Appendix E.

6.2.1 PRESSURE HULL VOLUME

As shown in Figure 2.3, the volume inside the pressure hull (V_{ph}) can be broken into the following categories:

- Mobility
- Weapons
- Command and Control (C³I)
- Ship Support (Auxiliaries, Habitability and Storerooms).

The size of each of these items is dependent on different aspects of the owner's statement of requirements and are described below.

6.2.1.1 MOBILITY VOLUME

This volume describes that portion of the hull which involves propulsion and power generation, to include tankage for any required fuel. For

conventional diesel electric submarines, the following relationship was developed in the MIT Math Model

$$V_{DE} = \text{SHP}(\rho_{DE}),$$

where ρ_{DE} represents the average mobility density. This relationship varies with installed shaft horsepower which changes proportionately with ship size if the required speed performance of the hull is fixed. For this model, the relationship was modified to include terms which reflect the additional volume of the AIP plant, i.e. energy converter, fuel storage, compensating water, product management system, and any change in battery size from the baseline.

$$V_{AIP} = \text{SHP}(\rho_{DE}) + \Delta V_{\text{Battery}} + V_{AIP}$$

6.2.1.2 WEAPONS and C³I VOLUME

The weapons volume is based on the amount of ordnance carried by the submarine and the number of torpedo tubes, thus the value is fixed by owners requirements and is unaffected by adding AIP capability.

$$V_{\text{weps}} = \text{No. Torp. Tubes}(\rho_{\text{TT}}) + \text{No.Reloads}(\rho_{\text{RL}})$$

The volume for C³I is likewise fixed by owners requirements and is a constant based on volume estimates from ships with similar capabilities.

6.2.1.3 SHIP SUPPORT VOLUME

This volume is multifaceted and includes the remaining volume inside the pressure hull, which is made up of berthing and messing facilities, storerooms, office spaces and auxiliary machinery spaces. Berthing, messing and office space are based on factors proportional to navy standards for crew size, while

storage is proportional to the length of the mission. These factors are then adjusted to add additional area for passageways, compensate for unusable area due to hull curvature and incorporate a standard deck height of 7 feet.

$$\text{Area Berthing / Messing: } (A_{bm}) = \text{Const.}(\text{Crew Size})$$

$$\text{Area Storerooms: } (A_{sr}) = \text{Const.}(\text{Mission Length})$$

$$\text{Area Other Spaces: } (A_{os}) = \text{Const.} + \text{Const.}(\text{Crew Size})$$

The required auxiliary volume includes a wide range of items, including but not limited to refrigeration and atmosphere control equipment, non-AIP variable ballast tanks and piping, as well as high pressure air and hydraulic systems. This volume is therefore proportional to the size of the ship, specifically V_{ph} . Because some auxiliary systems are sized for the crew, this factor is also affected by manning.

$$V_{aux} = \text{Const.}(V_{ph}) + \text{Const.}(\text{Crew Size})$$

$$V_{ss} = V_{aux} + [(\text{Const.})(A_{bm} + A_{sr} + A_{os})]$$

In summary:

$$V_{ph} = V_{AIP} + V_{weps} + V_{C^3I} + V_{ss}.$$

6.2.2 OTHER VOLUMES

With parameters established for pressure hull determination, estimation of the remaining volume between the pressure hull and hull envelope are based on the size of the ship, similar to the auxiliary volume. The outboard volume (V_{ob}) accounts for items outside the pressure hull which are solid with respect to the

sea in that they will not flood with water, such as high pressure air bottles and structural members. V_{ob} is proportional to V_{ph} , and when added to V_{ph} , the total is termed the everbuoyant volume (V_{eb}). The free flood volume (V_{ff}) is the space inside the envelope which floods on submerging, and from a naval architecture viewpoint does not contribute to buoyancy when surfaced. V_{ff} is proportional to V_{eb} . Both factors are based on historical data.

$$V_{ob} = \text{Const.}(V_{ph})$$

$$V_{eb} = V_{ob} + V_{ph}$$

$$V_{ff} = \text{Const.}(V_{ph})$$

The remaining volume is allotted to reserve buoyancy and encompasses the main ballast tanks. This volume is based on a percentage of the everbuoyant volume, nominally 10 - 15 percent, and is set by the owners requirements based on the expected mission of the submarine. When added to the everbuoyant volume, main ballast tank volume adds up to the submerged volume.

$$V_{mbt} = \text{Const.}(V_{eb})$$

$$V_{sub} = V_{eb} + V_{mbt}$$

$$V_{env} = V_{sub} + V_{ff}$$

6.3 WEIGHT ESTIMATES

The details of the weight estimates are contained in Appendix F.

6.3.1 SURFACED DISPLACEMENT

Similar to the pressure hull volume, the surfaced displacement, or normal surfaced condition (NSC) is a summation point for the estimated weights in the ship. Figure 2.3 listed seven weight groups that make up the NSC, however this model combines some of the groups based on information which can be estimated from Stenard.

6.3.1.1 STRUCTURAL WEIGHT

Structural weight includes the pressure hull itself, as well as the scantlings necessary to provide the required hull stiffness. As a result, this factor is proportional both to the final size of the ship as well as the diving depth, which is set by the owner. Stenard gives the following relation for structural weight:

$$W_{str} = \{NSC[Const.(Diving Depth) + Const.]\}.$$

This weight is not directly affected by the addition of an AIP power plant.

6.3.1.2 MOBILITY WEIGHT

For diesel electric submarines, the following describes the relationship for the weight of mobility:

$$W_{mob} = \text{Battery Weight} + Const.(SHP)^{0.64}.$$

This relationship varies with the installed shaft horsepower and battery weight, both of which will vary directly with ship size if the required speed performance of the hull is fixed. Mobility weight is the one weight parameter which is directly

affected by the addition of AIP capability. As described in Section 6.2.1.1, the relationship is modified to include terms which reflect the additional weight of the AIP plant, and any change in battery weight from the baseline:

$$W_{mob} = \text{Battery Weight} + \text{Const.}(\text{SHP})^{0.64} + \Delta W_{\text{Battery}} + W_{\text{AIP}}.$$

6.3.1.3 WEAPONS AND C³I WEIGHT

Similar to the weapons volume, weapons weight is based on the number of torpedo tubes plus factors related to the volume of the weapons space. The number of reloads do not figure into this weight because they are accounted for in the variable load of the ship. Unlike the volume determination for C³I, the best estimate of this weight is obtained by using a percentage of the weapons volume, which is closely linked to the sensor and electronic capabilities of the ship.

$$W_{\text{weps}} = [\text{Const.}(V_{\text{weps}}) + \text{Const.}(\text{No. Torp Tubes}) + \text{Const.}]$$

$$W_{\text{C}^3\text{I}} = \text{Const.}(V_{\text{weps}})$$

6.3.1.4 SHIP SUPPORT WEIGHT

As described for ship support volume, this weight encompasses auxiliaries and habitability items. By similar reasoning, auxiliary weights are proportional to the size of the ship and is scaled by NSC, while habitability is proportional to the size of the crew. The following describes the relation for ship support weight:

$$W_{ss} = \text{Const.}(\text{NSC}) + \text{Const.}(\text{Crew Size}).$$

6.3.1.5 FIXED BALLAST AND VARIABLE LOAD WEIGHT

All submarines are designed with added weight, normally in the form of lead ballast, to provide a margin for weight growth over the life of the ship (margin lead), and to help balance longitudinal moments (stability lead). The total amount of lead is set as a percentage of NSC and is normally greater than 5 percent.

Variable load weight represents a broad category of items which are not a fixed part of the ship but are weights that can be expected to vary from mission to mission, such as the embarked crew and initial weapons load, or items that are depleted over the course of a patrol, such as fuel, oil and provisions. Because these weights will generally decrease over a mission, an equal amount of weight must be added so the ship can maintain a neutrally buoyant condition. This weight addition is accomplished via the variable ballast system. Reference[68] describes an investigation of the effect of AIP fuels on this factor and determined that the proportion of AIP fuel is similar to that for conventional diesel fuel allowances. As a result, this factor is adjusted such that the final weight of variable loads, bunker (diesel) fuel and AIP fuel together represent the same percentage of the total variable load for conventional submarines.

$$W_{fb} = \text{Const.}(\text{NSC})$$

$$W_{vl} = \text{Const.}(\text{NSC})$$

In Summary:

$$\text{NSC} = W_{str} + W_{mob} + W_{weps} + W_{C^3I} + W_{ss} + W_{fb} + W_{vl}.$$

By solving the above equation for NSC, the total weight to be supported by displaced water at all times is determined and must be equated to the everbuoyant volume determined earlier. This balance is achieved by increasing the fixed ballast percentage if the equivalent weight of the displaced seawater volume is greater than NSC (volume limited). If the estimated ship weight is greater than the equivalent displaced seawater volume weight, the dimensions of the hull envelope are increased, which will proportionately increase the everbuoyant volume until the two values match (weight limited).

6.4 POWERING AND ENDURANCE

Once the initial estimates of weight and volume are made, a check must be made to see if sufficient allowance has been made for required propulsion and electrical hotel loads, as well as endurance requirements. This section describes the method used to model these estimates. The details for this section can be found in Appendix G.

6.4.1 POWERING

6.4.1.1 HYDRODYNAMICS

While the Albacore style hull helps to reduce resistance, a certain amount of resistance must be overcome to push the hull form through the water. This resistance can be divided into two broad categories: hull resistance and appendage resistance.

Hull resistance has three component parts:

-Frictional (C_f) which is a function of ship length, speed and the viscosity of the seawater. An accepted correlation for C_f is given by:

$$C_f = \frac{0.075}{(\text{Log}_{10} R_n - 2)^2}; \quad \text{where } R_n = \frac{(\text{Speed})(\text{Length})}{(\text{kinematic viscosity})}$$

-Residual (C_r) which represents the resistance generated by pressure differences along the hull. Jackson gives the following relation for C_r :

$$C_r = \frac{0.000789}{\frac{L}{D} - k_2}; \quad \text{where } k_2 = 6 - 3.6(\text{Dia.})C_{sa} - 2.4(\text{Dia.})C_{sf}$$

-Correlation Allowance (C_a), which represents an adjustment between results obtained by model testing and actual results obtained from full size ship tests:

$$C_a = 0.0004.$$

Because these resistance coefficients are all based on the size of the hull, they are brought together with the wetted surface described in Appendix D.

Appendage resistance is made up of:

-Bridge (Sail) resistance, which varies with the total surface area of both sides of the sail, and is calculated by multiplying this area by the following drag coefficient:

$$C_{DB} = 0.009$$

$$R_{\text{bridge}} = C_{DB}(\text{Area Sail}).$$

-Appendage resistance varies with the total surface area of the control surfaces; bow planes, stern planes and rudder. Jackson has shown that for good existing submarine designs, this resistance can be approximated by:

$$R_{\text{append.}} = \frac{(\text{Length})(\text{Diameter})}{1000}.$$

With an estimate of the total resistance on the ship, the effective horsepower (EHP), which is the power necessary to push the hull through the water, can be calculated by the following:

$$\text{EHP} = \text{Const.}(\text{Speed})^3 [WS(C_f + C_r + C_a) + R_{\text{bridge}} + R_{\text{append.}}].$$

EHP is translated into shaft horsepower (SHP) through the propulsive coefficient (PC):

$$\text{SHP} = \frac{\text{EHP}}{\text{PC}}.$$

PC represents the efficiency of the propeller in transferring the power at the propeller to the ocean, and is a function the open water characteristics of the propeller (η_o), the hull efficiency (η_h), the relative rotative efficiency (η_{rr}) which accounts for turbulence in the wake in the vicinity of the propeller:

$$\text{PC} = (\eta_o)(\eta_h)(\eta_{rr}).$$

For this model, the PC determined for a seven bladed, 15.5 ft diameter fixed pitch propeller in Reference [68] is assumed. Any comparisons made in the

model with various propeller options are accomplished by adjusting the value for PC.

6.4.1.2 PROPULSION MOTOR TURNDOWN

The propulsion motor installed in any shipboard application must be sized to meet high end power requirements. However in the case of AIP applications, the motor will be operated at a power much less than its rated value. Operation at this lower power may result in a lower motor efficiency and a lower overall transmission efficiency for the conversion of electrical power to shaft horsepower.

Conventional DC motors are presently installed in many diesel electric submarines. Short of utilizing Permanent Magnet AC motor technology, Section 3.1.2, AC synchronous motors employing power electronics technology are available now for use in propulsion applications. These motors do not suffer from the same efficiency loss as conventional DC motors [45]. For this model, motor efficiency was assumed to be constant over the range of operation.

6.4.2 SNORKELING POWER AND BUNKER FUEL CALCULATION

This power represents the additional resistance on the hull due to wave/hull interactions near the surface while operating submerged with the snorkel mast extended. The real effect on the ship is that more power is required while at periscope depth to maintain a given speed. The additional power is given by

$$\text{SHP}_{\text{wave}} = \text{Const.}(WS)(C_{\text{wave}}); \quad \text{where } C_{\text{wave}} = \frac{\text{Const.}}{4\left(\frac{L}{D} - k2\right)\left(\frac{L}{D}\right)^2},$$

and is used to determine the amount of bunker fuel required for the ship to make the stated diesel endurance. The weight of bunker fuel is given by the following relationship which combines range, diesel engine economy and total engine load:

$$\text{Fuel (ltons)} = \frac{(\text{Range})(\text{sfc})[(\text{SHP}_{\text{wave + subm.}}) + 1.34(\text{HOTEL LOAD}_{\text{DE}})]}{2240(\text{tailpipe})(\eta_{\text{trans}})(\text{Snorkel Speed})}$$

6.4.3 HOTEL LOADS

Hotel loads represent all the parasitic electrical loads on the ship which are required to support essential ship functions. Traditionally, diesel submarine hotel loads are smaller than on nuclear submarines because electrical power is a premium, coming directly from the battery while submerged. AIP really does little to alleviate the problem completely because at low speeds, the electrical hotel load is predicted to be several times larger than that required for propulsion. Stenard gives the following relation for calculating hotel load:

$$\text{HOTEL}_{\text{DE}} (\text{kW}) = \frac{1.5(V_{\text{mob}}) + 4(V_{\text{C}^3\text{I}}) + 1.5(V_{\text{SS}}) + V_{\text{WEPS}}}{1000}$$

Hotel load is a function of various ship volumes which grow as ship size increases. While its absolute size is small, the factor of four applied to the volume for C³I reflects the intensive power nature of electronic equipment. Since hotel load scales with submarine size, no adjustment was made for the AIP plant itself, however a constant value of 15 kW was added to account for the power necessary to operate one CO-H₂ burner and one CO₂ scrubber for

atmosphere control, equipment not normally found on diesel-electric submarines.

$$\text{HOTEL}_{\text{AIP}} = \text{HOTEL}_{\text{DE}} + 15\text{kW}$$

Some additional relief that AIP may provide on hotel load comes from the pure water generated by some fuel cell plants, or the potential for bottoming cycles or other use of waste heat, eliminating some electrical heating requirements. None of these considerations are incorporated in this model.

6.4.4 BATTERY ENDURANCE

AIP can provide relatively low power, 500 kW, for significant periods of time (weeks). AIP cannot provide the power, 4000-5000 kW, necessary for high speed bursts for any period of time. The solution to this short term, high power problem is the storage battery, which can provide the burst energy necessary to make high speeds for several hours at a time. Thus the battery endurance at a given speed is an important quantity to evaluate for any AIP model. The general relationship for battery endurance is given by:

$$\text{Batt. Endur. (hrs)} = \frac{(\text{Batt. Size})(\text{Batt. Capacity})(\eta_{\text{coul}})(\eta_{\text{trans}})}{[(0.746 * \text{SHP}) + \text{HOTEL LOAD}_{\text{AIP}}]}$$

In this relationship, battery capacity is the kW rating for the battery at a particular discharge rate, assumed to be about 2 hours for burst conditions and 80+ hours for creep calculations. For any periods of time estimated to be greater than these two assumptions, i.e. a burst period estimated as 2.5 hours, the results are conservative, as a battery will generally deliver more total energy when discharged at a slower rate. η_{coul} represents the efficiency associated

with recovering energy stored in the battery. In this model, any battery can be represented as long as the rapid and slow discharge rates are known and an estimate of η_{coul} made.

This same relationship in a different form is used to calculate any change in battery weight and volume from the baseline submarine. For a given endurance period, the required battery size can be determined. The difference in the number of batteries from the baseline is then determined and using weight and volume estimates for a standard battery, a change in battery weight and volume can be calculated and applied to the mobility estimate for the ship.

6.5 THE AIP PLANT

The AIP plant is modeled using the data presented in Appendices A and B for the various plant and reactant options. For a generic AIP plant, the following component parts were considered:

-Plant type	(PEM, CCD, etc.)
-Reformer required	(YES, NO)
-Oxidant type	(LOX, H ₂ O ₂ , etc.)
-Fuel type	(H ₂ , Diesel, Methanol, etc.)
-Other fluid	(KOH/WATER, ARGON, Comp Water)
-Product mgmt. system	(YES, NO)
-Breathing oxygen	(YES, NO. Req'd if LOX not designated as the choice for oxidant)

For each item, a weight ($\frac{\text{kg}}{\text{kW}}$ or $\frac{\text{kg}}{\text{kW-hr}}$) or volume ($\frac{\text{ft}^3}{\text{kW}}$ or $\frac{\text{ft}^3}{\text{kW-hr}}$) factor as appropriate was determined so that an estimate of the total weight and volume of that part could be made. The parts that are applicable to a given plant are then summed to give a total AIP weight and volume. These values are then input to the weight and volume relations for mobility to give total AIP capable values.

CHAPTER SEVEN

7.0 COMPUTER CODE DEVELOPMENT

The computer code for this model was written using Turbo C++, Version 3.0 for DOS by Borland, incorporating the submarine model concepts presented in Chapter Six.

Figure 7.1 provides an overview of the code, titled "**SUBSIZE**", showing the flow path through the functions to achieve a balanced design. Input data in file **SUBSIZE.CPP** is modified by the user before each run to establish the desired ship constraints. The AIP plant is defined in file **AIPSIZE.CPP** for one of six different AIP plant options.

The computer code, including the main program, functions, input data and sample output is contained in Appendix I.

7.1 OVERVIEW

Referring to figure 7.1, the user selects the desired parameters for the ship in the main program, **SUBSIZE.CPP**. The first functions called estimates the volumes and then the required hull envelope. Weights are estimated next, since some weight estimates are based on the volumes already determined. Weights and volumes are then matched in a looping process which checks the value of NSC against a displacement equivalent to V_{eb} :

$$\Delta_{v_{eb}} = \frac{V_{eb}}{35}.$$

NSC and $\Delta_{v_{eb}}$ are matched by the following process:

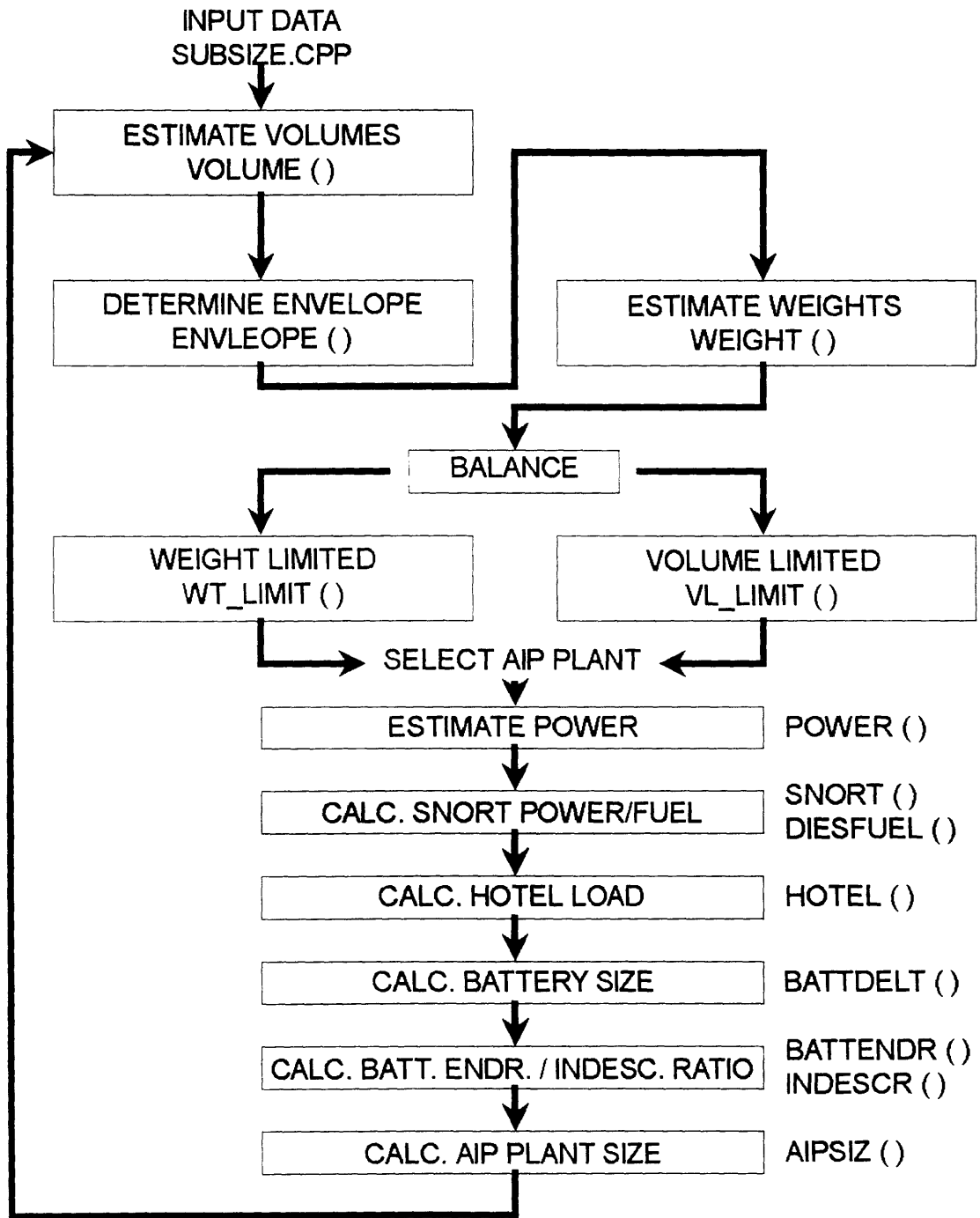

"SUBSIZE" Flowchart

Figure 7.1

<p style="text-align: center;">WEIGHT LIMITED (NSC > Δv_{sh})</p>	<p style="text-align: center;">VOLUME LIMITED (NSC < Δv_{sh})</p>
<p>The overall length of the hull envelope is increased in 0.1 foot increments until the resulting envelope displaces enough water to equal NSC. Volumes are then recomputed.</p>	<p>The amount of lead is increased by adjusting the lead margin in increments of 0.04 percent (approximately 100 ltons) until NSC equals Δv_{sh}. Weights are then recalculated.</p>

The weights and volumes are matched in this fashion, rather than refining the estimates of weights or volumes, because in this first look at a concept design, not enough information is usually available to adjust weights and volumes. Only after a complete trip around the design spiral can such adjustments be made.

With a balance achieved between weights and volumes, the estimates for ship power, fuel load, hotel load, and battery endurance and indiscretion ratio are made. These parameters are calculated first because they will be used to provide the estimate of the size of the AIP plant and its required fuel, as well as any increase in the size of the battery. With the power requirements established, the size of the particular AIP plant is calculated and an adjustment in the size of the battery estimated. These values are then added to the weights and volumes for mobility which will typically increase these values.

Now that the estimates for weight and volume have changed, the program enters an iterative loop where the process described above is repeated. Each time through, new values for ship powering, hotel load and battery endurance and indiscretion ratio are calculated because as the ship changes in size, so will

these values. At the end of each loop, a revised total AIP plant size is determined along with a revised change in battery size. These new values then replace the previous values in the mobility weight and volume estimates. Iterations are continued until the change in NSC from one iteration to the next is less than one percent.

Program output includes a restatement of the key input parameters as well as those parameters which were calculated or adjusted by the program such as lead margin. The output also summarizes the volume and weight estimates for the submarine hull, as well as weight and volume estimates for the AIP plant, broken down by plant, reactants and auxiliaries.

A sample program output sheet is contained in Appendix I.

CHAPTER EIGHT

8.0 RESULTS AND CONCLUSIONS

The goal of this thesis was to develop a computer code to evaluate various AIP propulsion options by synthesizing a submarine hull according to certain owners requirements for mission capability and performance. This code can be used to support the concept design of AIP submarines.

The model developed gives good results when compared to other studies of AIP submarines. Validation of the model is addressed in Section 8.1 with AIP and other technological impacts evaluated in section 8.2. Section 8.3 illustrates the usefulness of the tool in performing trade-off studies as a part of the submarine design process.

8.1 MODEL VALIDATION

It is difficult to measure the accuracy of this model against real world submarines for several reasons. The number of true non-nuclear AIP submarines is small, and many of the technologies evaluated in this thesis are still theoretical in terms of full scale applications. Additionally, the details of any real or proposed ships are carefully guarded by the respective consortiums and governments conducting AIP investigations.

The AIP option has been investigated by several student submarine design teams in the Naval Construction and Engineering Program at the Massachusetts Institute of Technology (MIT) in a variety of scenarios and missions, but AIP has always fallen short in trade-off studies when compared to nuclear power and total ship performance. One recent study at MIT evaluated the AIP option from the perspective that AIP was the only option for extending

underwater endurance, forcing an detailed evaluation of AIP concerns and limitations [60]. This study evaluated PEM fuel cell with methanol and Aluminum Oxygen semi-cell technologies, selecting one option for a concept design. In the concept design, a detailed evaluation of discrete submarine weights and volumes and arrangements was made to validate the approach used and to verify the appropriateness of the margins assumed. The approach to submarine synthesis used in that study was paralleled by this thesis with results presented in Figure 8.1.

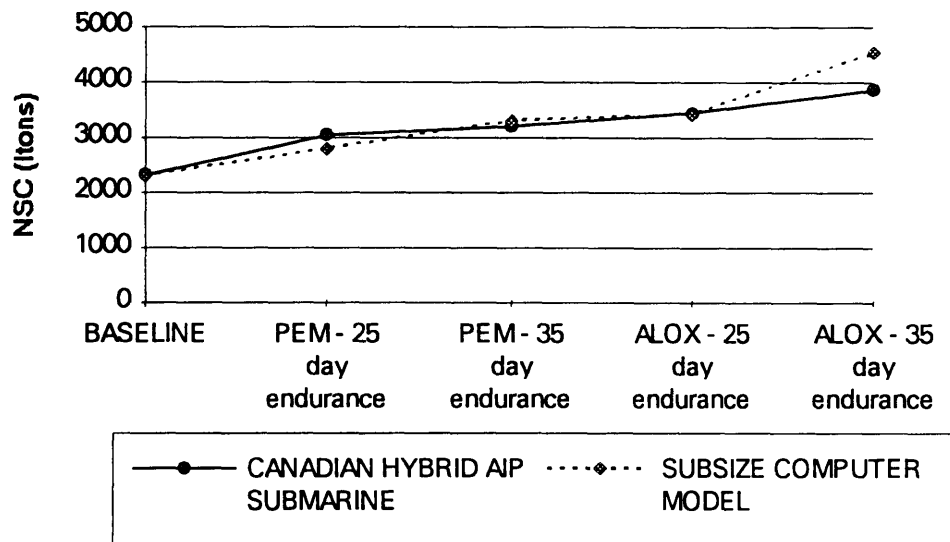

Comparison of Canadian Hybrid Submarine and SUBSIZE results

Figure 8.1

As can be seen, the results of the SUBSIZE model for NSC closely follow the findings from the Canadian submarine study. While the same margins and scaling factors used in the study were duplicated in the computer model,

detailed design decisions in the Canadian submarine study had a significant impact on the final results for each variant. Detailed decisions of this sort were not included in the SUBSIZE model results.

8.2 GENERAL RESULTS

For many of the figures presented, results are compared by NSC between variants. This attribute was chosen for comparison purposes because it represents the balancing point in the model between weights and volumes. NSC also has a significant impact on other attributes such as installed SHP and AIP plant capacity.

Results showed each of the AIP options to be volume limited, requiring the model to add lead ballast by increasing the lead margin to achieve a balanced design. This is attributed to the fact that the overall AIP plant has an average density less than that of seawater (64 lbs/ft³), Table 8.1.

Table 8.1
Comparison of AIP Plant Densities

AIP Plant**	AIP Weight (ltons)	AIP Volume (ft ³)	Plant Density (lb/ft ³)
Aluminum	476.99	25,627.63	41.69
CBC	500.47	46,841.82	23.93
CCD	744.34	67,824.4	24.58
MCFC	252.4	22,991.55	24.50
PEM	278.12	23,323.5	26.71
Stirling	699.11	64,831.88	24.15

**25 day endurance, 8 kt AIP speed, 20 kt burst speed.

Supporting data for each of the figures in this chapter can be found in Appendix H.

8.2.1 OVERALL AIP IMPACT

Many investigations have been conducted regarding the benefits and limitations of different AIP options. It is not unexpected that the results obtained with the SUBSIZE model should parallel results obtained by others. Figure 8.2 presents the results by AIP plant for various ship and AIP attributes and shows that the MCFC plant results in the smallest ship for a common set of requirements. The PEM plant is closely matched, and given the shipboard suitability issues and operating experience for each plant, it can be understood why the PEM fuel is being actively pursued by many nations. The CCD engine is predicted to require the largest ship size of the three heat engines evaluated due to its generally higher specific plant weight and high specific reactant consumption rates, Table A.1. Despite these results, the CCD is a popular option because diesel technology is readily available. The Aluminum Oxygen plant ranked midway between the fuel cells and heat engines.

When the AIP endurance is varied as in Figure 8.3, the impact on ship size shows that the variance in ship weight is larger for those plants whose specific reactant consumption rates are higher, specifically the heat engine plants. The trends observed in Figure 8.3 are consistent with those presented in reference [52].

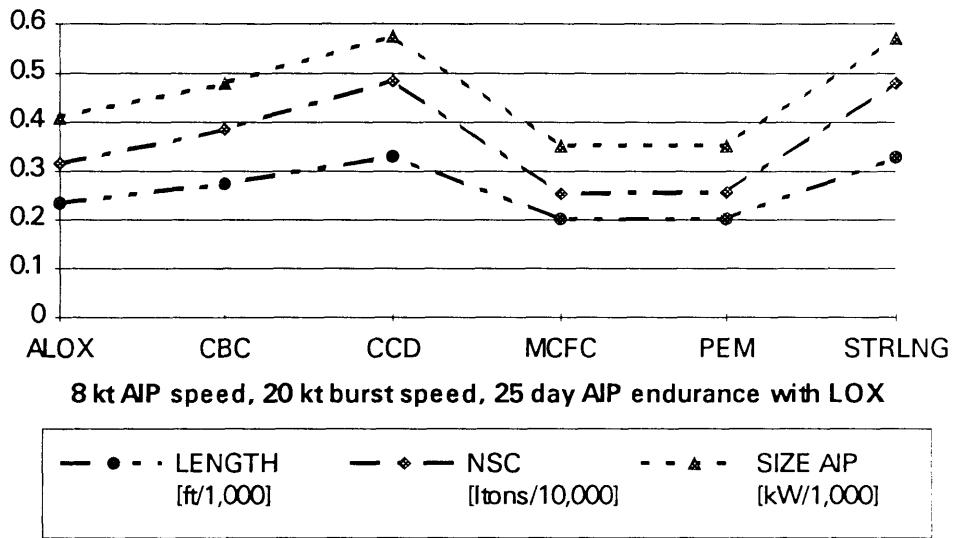

Comparison of AIP Plants

Figure 8.2

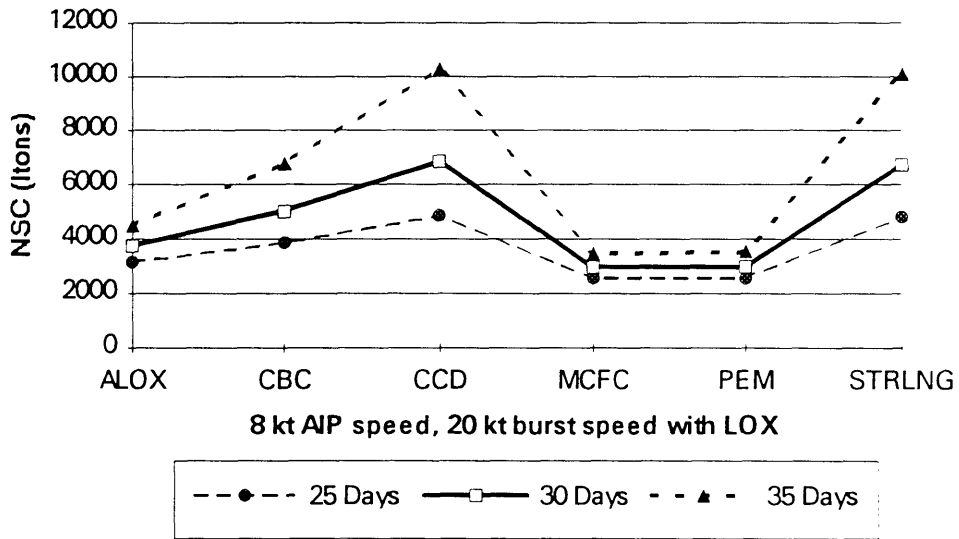

AIP Plant Variation with Endurance

Figure 8.3

8.2.2 IMPACT OF REACTANTS

Figures 8.4 and 8.5 show the effect of various reactant storage methods on NSC. For comparison purposes, the PEM plant with methanol was chosen for the oxidant storage variation and the PEM plant with LOX chosen for the fuel storage variation. All other attributes for the ships were held constant.

Of the four oxidant storage methods evaluated, LOX, HTP and sodium perchlorate all have a similar impact on ship size, while gaseous storage methods compare poorly. These results are generally in agreement with figure 5.5, except that sodium perchlorate does not show the expected advantage in terms of oxygen density. Gaseous storage is the worst because of the large weight of the oxygen flasks compared to oxygen, Table B.1, with the internal storage option suffering significantly because of the increased volume packing factor. While competitive with LOX, HTP suffers from a history of mishaps and difficulty in handling and will no doubt face significant opposition. The use of sodium perchlorate in this size application may also be met with some skepticism.

Figure 8.5 presents the results for various hydrogen storage options and compares well to the trends of Figure 5.2. Next to methanol, liquid hydrogen has the least impact on ship size, but presents many practical engineering issues in its implementation. Metal hydrides enjoy great volume efficiency, but pay a significant penalty in weight, forcing ship size to grow significantly to carry the high weight of the hydride bed. Gaseous hydrogen storage is shown to be beyond the realm of practicality as expected, due to the very low ratio of stored hydrogen weight to that of its vessel.

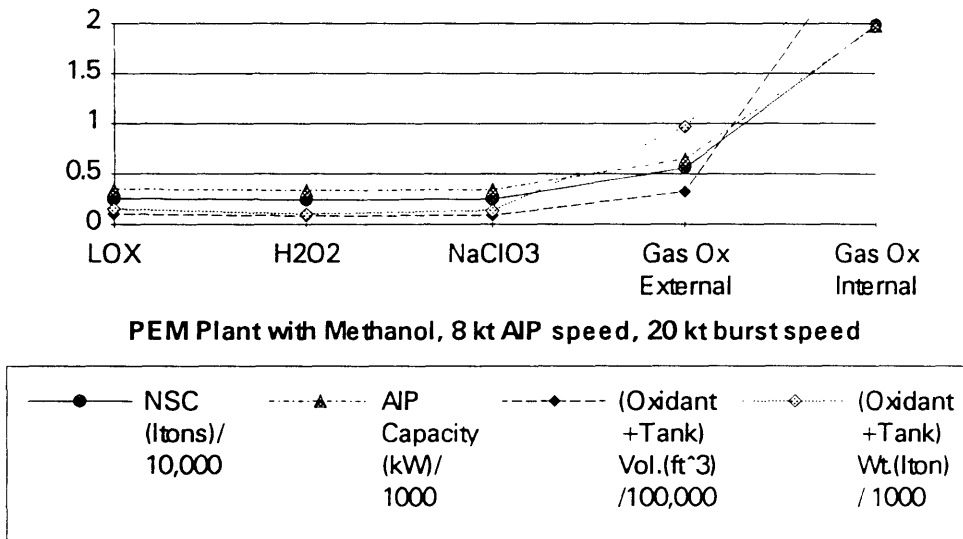

Comparison of Oxidant Storage Methods

Figure 8.4

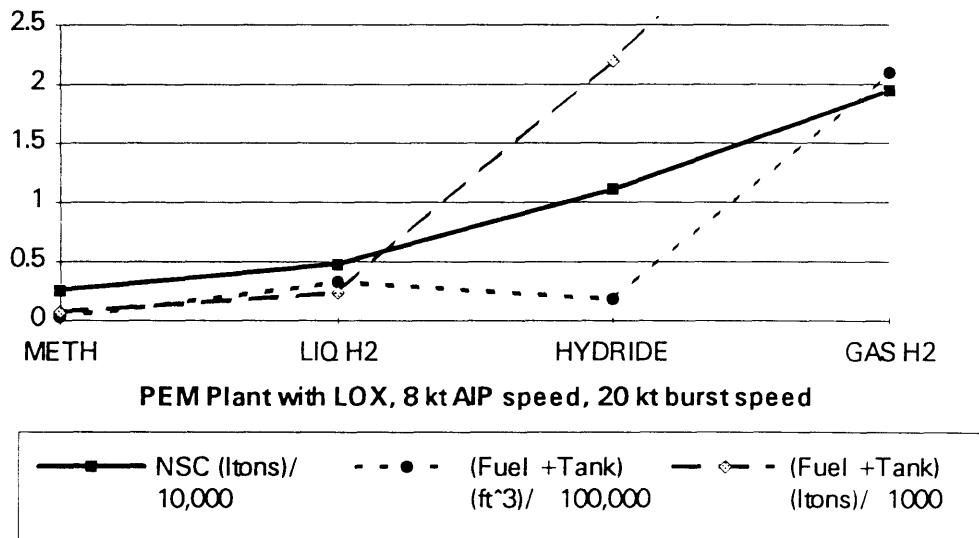

Comparison of Hydrogen Storage Methods

Figure 8.5

8.2.3 IMPACT OF OTHER TECHNOLOGIES

Because the model considers the impact of AIP on the total submarine design, certain ship constraints can often mask expected results. This concept is evident in the comparison of battery types on ship size. In the model, battery size is constrained to satisfy endurance requirements at both creep speed (90 hours) and at burst speed (2 hours). The general trend through all results shows that the creep requirement is limiting. In Figure 8.6, the use of a LAIS battery, which is assumed to have the same discharge characteristics as the lead acid battery but a higher energy density, results in a smaller ship, while the Ni/Cd option, which has an energy density between the two does not follow the same trend. This difference can be explained by the relatively flat discharge curve for Ni/Cd batteries over a range of discharge rates, Figure 4.9, which results in a slightly larger installed battery and significantly more burst endurance.

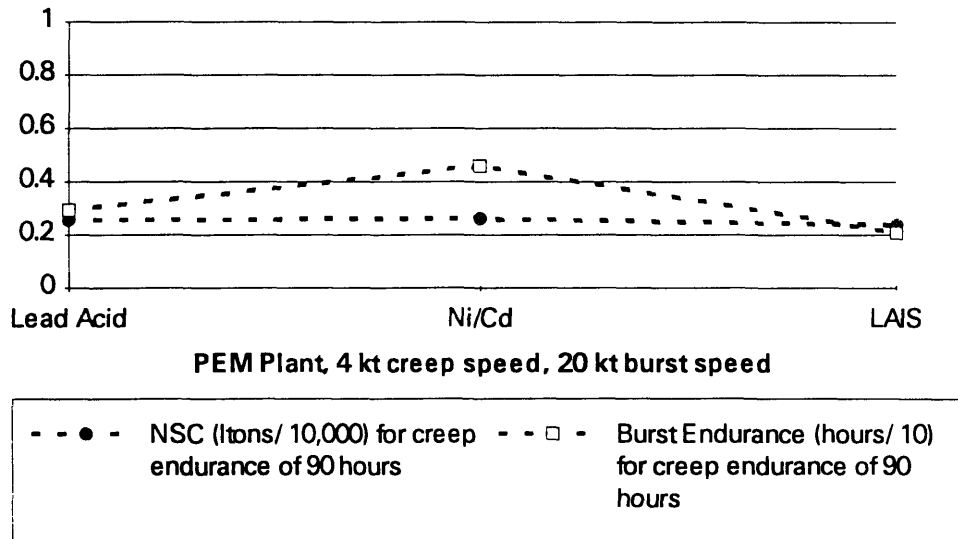

Comparison of Battery Options with Fixed Creep Endurance Requirement

Figure 8.6

By adjusting the model to fix burst endurance at two hours, Figure 8.7, ship size is decreased by approximately 5 and 15 percent respectively for lead acid and Ni/Cd options but not for LAIS which had the closest balance between the battery endurance scenarios. These results show that next to the AIP plant, battery endurance requirements have a significant impact on the overall submarine design.

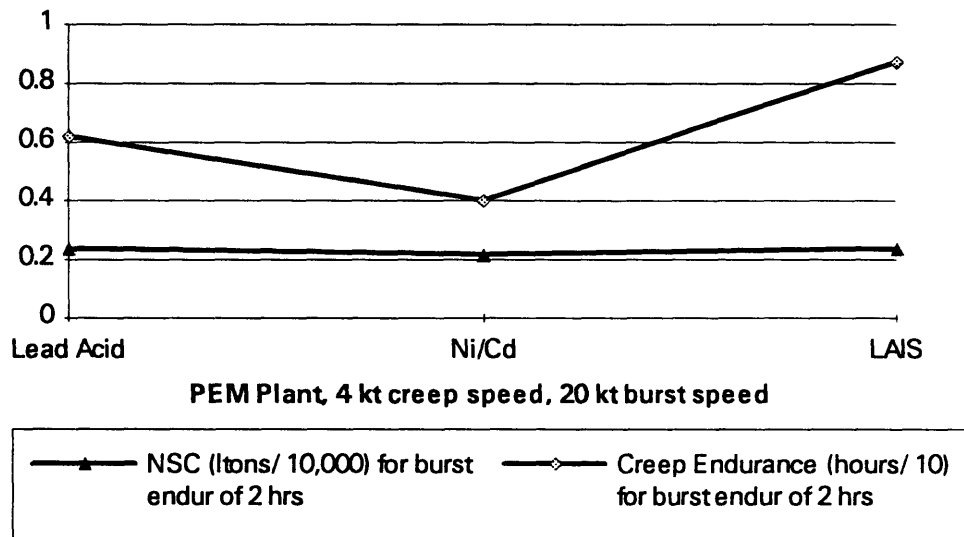

Comparison of Battery Options with Fixed Burst Endurance Requirement

Figure 8.7

For shaft propulsion options, variations in propulsive coefficient and motor type were evaluated. For the different motor types, the real impact on ship synthesis is in the weight required for each option, with results in Table 8.1. While both advanced motor options have less actual motor weight, the model adds back lead ballast due to the volume limited nature of the AIP submarine, which results in a heavier submarine in the synthesized model. The true impact

Table 8.2

Effect of Propulsion Motor Type on NSC**

Motor Type	NSC (ltons)	Final Lead Margin
Conventional	2564.36	0.112
Permanent Magnet AC	2663.92	0.147
Superconducting Homopolar DC	2660.67	0.137

**25 day endurance, 8 kt AIP speed, 20 kt burst speed

of this weight reduction would have to be evaluated in detail when the first reconciliation of weights is done in the concept design process.

In varying the propulsor type, an improvement in propulsive coefficient is evident in smaller plant sizes and fuel volumes. Figure 8.8 shows the results of increasing the propulsive coefficient by 10 percent. As before for varied endurance, the reduction in NSC is more significant for ships with higher specific reactant consumptions.

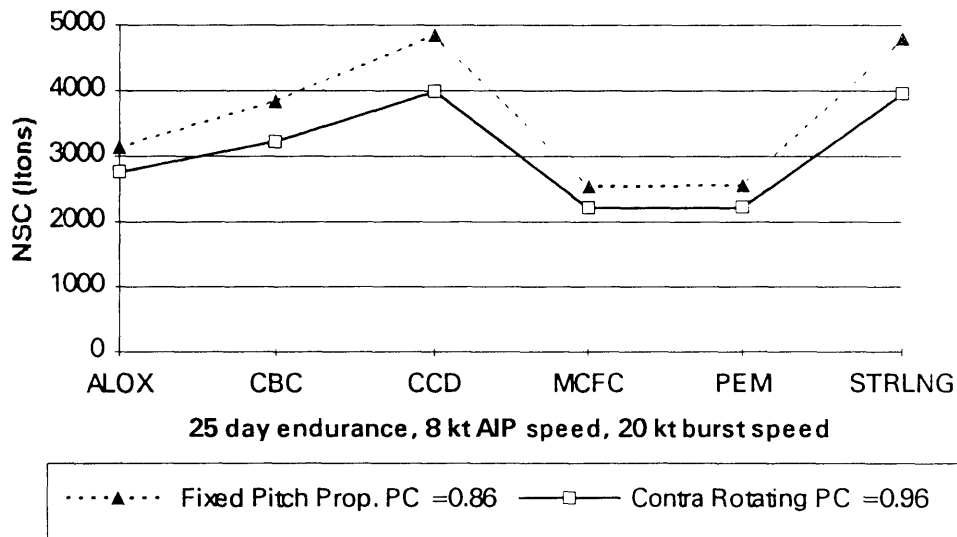

Effect of Propulsive Coefficient on NSC

Figure 8.8

8.3 SHIP TRADE-OFFS

As explained in Chapter 2, the design process is iterative, with many trade-offs and compromises conducted to achieve a balanced design which meets the owners requirements. The usefulness of the SUBSIZE model is illustrated here with several examples which show how varying certain requirements can affect the ship design.

Chapter 6 showed how decreasing the length to diameter (L/D) ratio can improve the powering of the submarine, which results in a reduction in installed SHP. Figure 8.9 illustrates the effect of increasing the hull diameter for one of the larger AIP variants, with its resulting decrease in NSC and SHP.

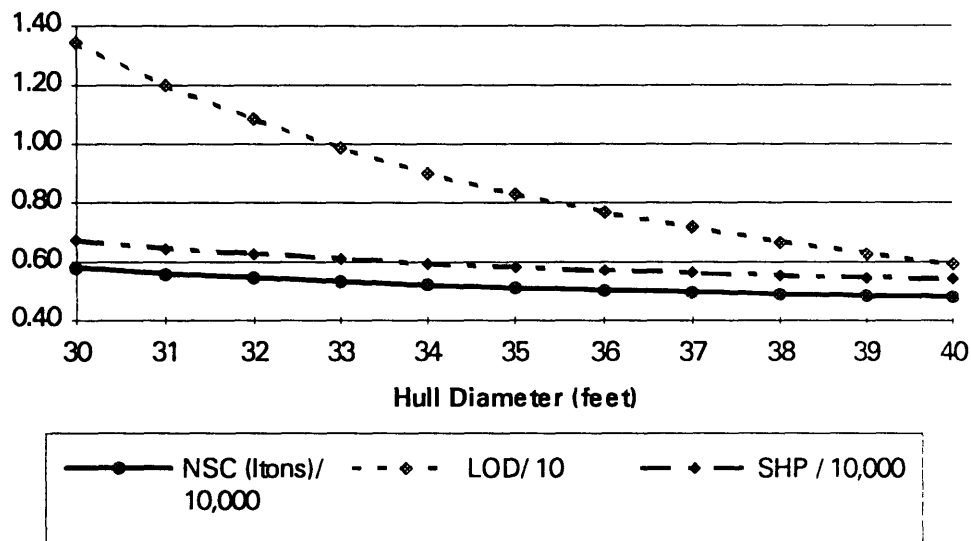

Effect of L/D ratio on NSC and SHP

Figure 8.9

The effect of increasing the desired AIP speed is shown in Figure 8.10. While this curve is similar to the trend for increasing AIP endurance, the point where increasing AIP speed has a significant impact on NSC is instructive. A

curve of this type tells the designer that a change in AIP speed of 1 knot below a threshold of about 7 knots is relatively insignificant when compared to a similar 1 knot increase in speed above 7 knots.

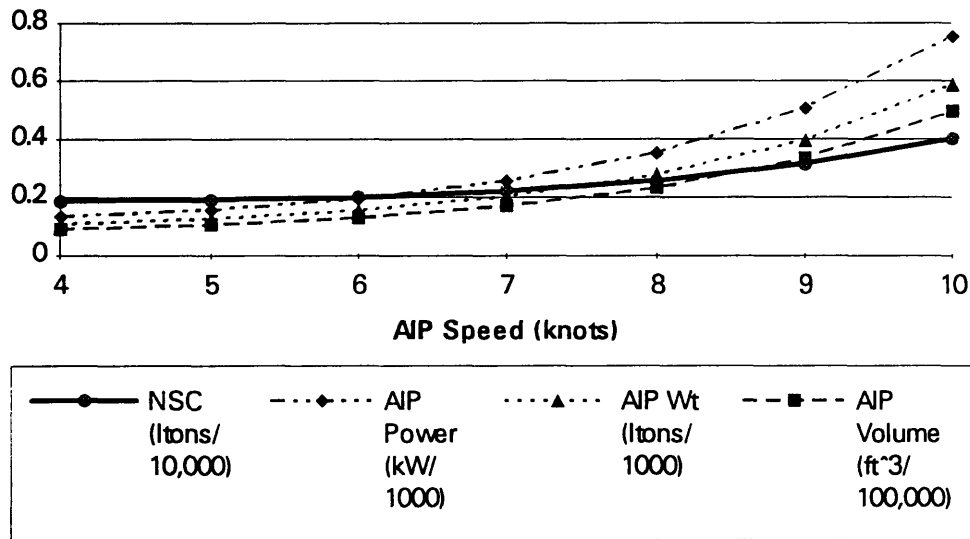

Effect of AIP Speed on NSC

Figure 8.10

One final operational parameter considered important for submarine operations is the indiscretion ratio, which is the amount of time spent snorkeling to recharge batteries divided by the total time for a charge-discharge cycle. While on AIP, this ratio will be essentially zero, however while transiting, this ratio may be significant. The goal of reduced intersection ratio must be balanced by the owners requirement to maintain an acceptable average speed of advance when transiting. Table 8.3 shows how SUBSIZE may be used to evaluate the effect of various transit and snorting speeds on indiscretion ratio and speed of advance.

Table 8.3
Indescrption Ratio and Speed of Advance
3 Knot Snort Speed

3	Indesc. Ratio	Transit Endurance (hours)	Charge Time (hours)	Speed of Advance (knots)
8	0.1	40.02	4.75	7.31
9	0.13	32.14	4.75	8.01
10	0.15	25.84	4.75	8.63
11	0.18	20.88	4.75	9.16
12	0.21	16.99	4.75	9.59
13	0.24	13.94	4.75	9.93
14	0.27	11.54	4.75	10.17
15	0.31	9.63	4.75	10.32
16	0.34	8.11	4.75	10.39

4 Knot Snort Speed

4	Indesc. Ratio	Transit Endurance (hours)	Charge Time (hours)	Speed of Advance (knots)
8	0.10	40.02	4.79	7.41
9	0.13	32.14	4.79	8.13
10	0.15	25.84	4.79	8.78
11	0.18	20.88	4.79	9.33
12	0.21	16.99	4.79	9.79
13	0.24	13.94	4.79	10.16
14	0.28	11.54	4.79	10.43
15	0.31	9.63	4.79	10.61
16	0.34	8.11	4.79	10.71

5 Knot Snort Speed

5	Indesc. Ratio	Transit Endurance (hours)	Charge Time (hours)	Speed of Advance (knots)
8	0.11	40.02	4.85	7.51
9	0.13	32.14	4.85	8.25
10	0.15	25.84	4.85	8.92
11	0.18	20.88	4.85	9.50
12	0.21	16.99	4.85	9.99
13	0.25	13.94	4.85	10.38
14	0.28	11.54	4.85	10.68
15	0.31	9.63	4.85	10.90
16	0.35	8.11	4.85	11.03

6 Knot Snort Speed

6	Indesc. Ratio	Transit Endurance (hours)	Charge Time (hours)	Speed of Advance (knots)
8	0.11	40.02	4.95	7.61
9	0.13	32.14	4.95	8.37
10	0.16	25.84	4.95	9.06
11	0.18	20.88	4.95	9.67
12	0.22	16.99	4.95	10.18
13	0.25	13.94	4.95	10.60
14	0.28	11.54	4.95	10.94
15	0.32	9.63	4.95	11.18
16	0.35	8.11	4.95	11.34

(Blank Reverse)

CHAPTER NINE

9.0 AREAS FOR FUTURE STUDY

Beyond the effort here to model the AIP submarine, further study in the area of AIP submarine design is warranted. Two possible areas for future study include:

SUBMARINE COST

SUBSIZE does not attempt to answer the question of cost of construction. The cost to build a submarine is well documented, but in the United States is based on nuclear submarine data, and is compounded by the desire by private shipbuilders to hold this type of data closely. As with the estimated parameters for the AIP plants, there are no operational units in production, thus the true cost of the AIP option is currently very difficult to estimate.

DETAILED POWER PLANT DESIGN

SUBSIZE assumes that an AIP plant will follow the same rules for arrangements as the conventional submarines used in its database. This assumption may not be strictly true since these plants bring with them components such as closed cycle gas turbines, LOX tanks and fuel tanks with bladders, components not presently found, if at all, on many submarines. Once more detailed plant data is made available, an effort to arrange several AIP propulsion plants would be instructive in refining the estimates of this model.

(Blank Reverse)

REFERENCES

- 1 Adams, V. W., *Possible Future Propulsion Systems for Submarines*, Journal of Naval Engineering, Vol. 31, No. 2, 1988.
- 2 Air Independent (Non-Nuclear) Propulsion (U), Anon., Office of the Chief of Naval Research, Arlington, VA., July 1991.
- 3 Amphlett, J. C., *Methanol, Diesel Oil and Ethanol as Liquid Sources of Hydrogen for PEM Fuel Cells*, Proceedings of the 28th Intersociety Energy Conversion Engineering Conference, Vol.1, Atlanta, GA, 1993.
- 4 Anderson, E., Briefing notes, NAVSEA 03E2, November 1993.
- 5 Application of Solid Oxide Fuel Cell (SOFC) Technology to Navy Propulsion and Ship Service Systems, Briefing Notes, February 1993.
- 6 Bagley, D., et al., "*Integrated Electric Propulsion System for Minimum Signatures Submarine Technology Illustrative Concept*", (unpublished paper).
- 7 Blackburn, C. M., et al, "*Cryogenic Storage of Submarine Breathing Oxygen: On-Board Design Concept*", The Johns Hopkins University/Applied Physics Laboratory, Report # JHU/APL TG 1338A, August 1983.
- 8 Brenner, R., *A Closed Cycle Diesel System for Submarines*, Maritime Defence, Vol. 8, No. 5, June 1993.
- 9 Brooks, R. M., Brown, A. J., Class notes from Massachusetts Institute of Technology Course 13.411: Methods of Ship System Design, Summer Term 1993.
- 10 Cervi, M., Personal communication, NSWC Annapolis, March 1994.
- 11 Clancy, T., SUBMARINE, A Guided Tour Inside a Nuclear Warship (New York: Berkley Books, 1993).
- 12 Carmichael, A. D., *Submarine Propulsion Systems: An Evaluation of Air Independent Propulsion Technologies*, Massachusetts Institute of Technology, Department of Ocean Engineering Report 92-6, December 1992.
- 13 Clarkin, L., Adams, M. J., *Canadian Second Generation AIP - A Formula for Success*, Paper presented at The Royal Institute of Naval Architects International Symposium on Naval Submarines 4, London, England, May 1993.
- 14 Corlett, R., *Quarter of a Century of Modern Submarine Battery Technology*, Maritime Defence, Vol. 11, No. 3, March 1986.
- 15 Cortana Corporation, Anon., *Air Independent Propulsion (AIP) Systems*, 1988.
- 16 Dade, T. B., *Advanced Electric Propulsion, Power Generation, and Power Distribution*, Naval Engineers Journal, Vol. 106, No. 2, March 1994.

- 17 Dahlander, P., *A Realistic Air Independent Propulsion System for Today and the Near Future*, Paper presented at the Royal Institute of Naval Architects International Symposium on Naval Submarines 3, London, England, 1991.
- 18 Doerry, N., Briefing notes, NAVSEA 03R22, March 1994.
- 19 Dutton, J. L., *Contrarotating Electric Drive for Attack Submarines*, Naval Engineers Journal, Vol. 106, No. 2, March 1994.
- 20 Edman, U., CAPT, RSwN and Hagerstedt, A., CDR, FMV, *The AIP Experience, the Operational Air Independent Propulsion in the Swedish Submarine NAECKEN. Background, Requirements, Performance, Installation and Results from Two Years of Operational Service*, Paper presented at The Royal Institute of Naval Architects International Symposium on Naval Submarines 3, London, England, May 1991.
- 21 Energy Research Corporation, Anon., *Phosphoric Acid Fuel Cell Power Source for Submersibles*, undated.
- 22 Fabris, G., *Liquid/Gas Flow Mixers*, NASA Tech Briefs, January 1994.
- 23 Foxwell, D., *Staying Under Longer: The SSK Closes the Gap*, Journal Article: source and date unknown.
- 24 Gibbons, D. W., Rudd, E. J., *The Development of Aluminum/Air Batteries for Propulsion Applications*, Proceedings of the 28th Intersociety Energy Conversion Engineering Conference, Vol.1, Atlanta, GA, 1993.
- 25 Grant, J.C., ed., Nickel-Cadmium Battery Application Engineering Handbook, General Electric Company, 1975.
- 26 Harper, A. D., *A New Approach to Air Independent Propulsion with CBC Engines*, Paper presented at INEC 92, Solutions to the Challenge of a New Defence Environment, September 1992.
- 27 Heine, W., Mattheis, P., Reuter, K., *Four-Circuit DC Motor for Submarine Propulsion*, Reprinted Article from Siemens Power Engineering & Automation, Vol. VII, No. 2, March/April 1985.
- 28 Hensler, J. H., PEng, Mark Tinney, K., *Submarine Propulsion: The Integrated Approach Including AIP Systems*, Paper presented at The Royal Institute of Naval Architects International Symposium on Naval Submarines 4, London, England, May 1993.
- 29 Heemskerk, K.A., *Air-independent Propulsion for Submarines: A Canadian Perspective*, Maritime Engineering Journal, Canada, 1991.
- 30 Hellquist, K., *Submarines with Air Independent Propulsion in the Present and Future Environment*, Paper presented at INEC 92, Solutions to the Challenge of a New Defence Environment, September 1992.
- 31 Hereford, L. G., et al., *Cryogenic Storage of Submarine Breathing Oxygen: Preliminary Safety and Hazard Analysis*, Johns Hopkins University Applied Physics Laboratory, Report # JHU/APL TG 1338B, August 1983.

- 32 Heywood, J. B., Internal Combustion Engine Fundamentals, (New York: McGraw-Hill, 1988).
- 33 Jackson, H. A., CAPT., USN (Ret.), P. E., *Submarine Parametrics*, Paper presented at the Royal Institute of Naval Architects International Symposium on Naval Submarines, London, England, 1983.
- 34 Jackson, H. A., CAPT., USN (Ret.), P. E., *Fundamentals of Submarine Concept Design*, Paper presented at the annual meeting of the Society of Naval Architects and Marine Engineers, New York, 1992.
- 35 Kerros, P., Leroy, P., Grouset, D., *MESMA: AIP System for Submarines*, Paper presented at the Royal Institute of Naval Architects International Symposium on Naval Submarines 4, London, England, 1993.
- 36 Knaack, I. K., Gruhl, E., Petersen, U. K., *Advantages of Air-Independent Propulsion Systems for Submarines Being in Service. The German Approach*, Paper presented at the Royal Institute of Naval Architects International Symposium on Naval Submarines 3, London, England, 1991.
- 37 Kosek, J. A., et al, *A Direct Methanol Oxidation Fuel Cell*, Proceedings of the 28th Intersociety Energy Conversion Engineering Conference, Vol.1, Atlanta, GA, 1993.
- 38 Kumm, W. H., *Optimized Fuel Cell Propulsion for Submarines*, Paper presented at the Royal Institute of Naval Architects International Symposium on Naval Submarines 3, London, England, 1991.
- 39 Laidley, R., Wagner, T., *The Canadian Navy's Dilemma: Which Canadian Air Independent Propulsion System is Better - Aluminum/Air or Fuel Cells*, Paper presented at INEC 92, Solutions to the Challenge of a New Defence Environment, September 1992.
- 40 Lusted, M., et al., *Littoral Warfare Submarine*, Design Project, Course 13.414, Ocean Engineering Department, Massachusetts Institute of Technology, May 1994.
- 41 Maritime Defence, Anon., *The Theory of the Lead Acid Battery*, Vol. 13, No. 3, March 1988.
- 42 Maritime Defence, Anon., *Bridging the diesel-electric/nuclear performance gap*, Vol. 16, No. 4, April 1991.
- 43 Maritime Defence, Anon., *Of Submarine Propulsion*, Vol. 16, No. 4, April 1991.
- 44 Mart, P.L., Margeridis, J., Brighton, D. R., *Fuel Cells for Submarine Air Independent Propulsion*, Materials Research Laboratory, Melbourne, Australia, 1990.
- 45 McCoy, et al., Olsen, E., Reynerson, C., *New Attack Submarine*, Design Project, Course 13.414, Ocean Engineering Department, Massachusetts Institute of Technology, May 1994.

- 46 McNair, E. J., *Closed Cycle Diesel Engines for Underwater Power*, Ship Department, Ministry of Defence, United Kingdom, date unknown.
- 47 McKee, L., "*HYDROGEN PEROXIDE for PROPULSIVE POWER, Production and Use by the Germans During World War II*", Presented at the Annual Meeting of the American Society of Mechanical Engineers, New York, December 1946.
- 48 Mills, A. F., *Heat Transfer*, (Boston, MA, IRWIN, 1992)
- 49 Moore, C., *Liquid Oxygen as an Oxidant for Underwater Vehicle Power*, Paper presented at INEC 92, Solutions to the Challenge of a New Defence Environment, September 1992.
- 50 Potter, I. J., et al, *Development of an IDI Diesel Engine Test Facility for Use with Non-Conventional Atmospheres*, Proceedings of the 27th Intersociety Energy Conversion Engineering Conference, San Diego, California, 1992.
- 51 Prins, I. C. A., *Atmosphere-independent Propulsion for Diesel-electric Ocean-going Submarines*, Maritime Defence, Vol. 14, No. 11, 1989.
- 52 Reader, G. T., Hawley, J. G., *Problems Associated With the Use of Synthetic Atmosphere Diesels in Naval Submarines*, Proceedings of the 24th Intersociety Energy Conversion Engineering Conference, Washington D.C., 1989.
- 53 Reed, J. R., *MIT Math Model for Conventional Submarines*, Massachusetts Institute of Technology Course 13.413, Independent Activities Period 1994.
- 54 Regensdorf, U., *Installation and Trials with the Closed Cycle Diesel on Board Ex-U1*, Paper presented at the Royal Institute of Naval Architects International Symposium on Naval Submarines 4, London, England, 1993.
- 55 Rosenfeld, R.L., Prokopius, P.R., Meyer, A. P., *Fuel Cell Power System Development for Submersibles*, Undated technical paper, International Fuel Cells, East Windsor, CT.
- 56 Russo, M., Personal communication, Fine Line Technologies, Inc., March 1994.
- 57 Sandrock, G. D., *Hydrogen Storage*, Paper presented at the Hydrogen Energy Symposium, Stockholm, Sweden, 1981.
- 58 Seymor, C. M., *Application of Air Independent Power Systems to Submarines*, Paper presented at INEC 92, Solutions to the Challenge of a New Defence Environment, September 1992.
- 59 Sinsabaugh, S., Personal communication, LORAL Corporation., April 1994.
- 60 Smith, R. E., Computer Analysis of Fuel Cell Power Systems Performance for Naval Applications, NSWC Carderock Bethesda, MD, Report Number CARDIVNSWC-TR-82-93/47, October 1993.
- 61 Stenard, J. K., *Comparative Naval Architecture of Modern Foreign Submarines*, Masters Thesis, Ocean Engineering Department, Massachusetts Institute of Technology, May 1988.

- 62 **Submarine Roles in the 1990's and Beyond**, Anon., Office of the Assistant Chief of Naval Operations for Undersea Warfare, January 1992.
- 63 **Submarine Storage Batteries, Lead Acid Batteries**, Naval Ships' Technical Manual (NSTM), S9068-G1-STM-010/CH-223.
- 64 Sylvester, R., An Introduction to Stirling Engines and Their Use in Submarines, **Maritime Engineering Journal**, Canada, date unknown.
- 65 Terry, J. L., Poole, A. J. , *Alternate (Air Independent) Emergency Energy Sources Study (U)*, prepared by Newport News Shipbuilding for DARPA, 1990.
- 66 **The Naval Architect**, Anon., *Small Submarine With Long Range CCD Propulsion From Fincaniteri*, May 1991.
- 67 **The Naval Architect**, *Australian COLLINS class submarine takes shape*, February 1993.
- 68 Thornton, G. B., et al, *Concept Design of a Canadian Hybrid Air Independent Propulsion (AIP) Submarine*, IAP Design Project, Ocean Engineering Department, Massachusetts Institute of Technology, January 1994.
- 69 Trimble, S., *Closed Brayton Engines for Undersea Applications*, Proceedings of the 24th Intersociety Energy Conversion Engineering Conference, Washington D.C., 1989.
- 70 Urbach, H. B.,Knauss, D. T., Quandt, E. R., *Advanced Concepts in Chemical Propulsion Systems for a 500-Ton Submersible*, Naval Engineers Journal, Vol.93, No. 1, February 1981.
- 71 Whitcomb, C., Briefing notes, NSWC (Carderock), Bethesda, MD, October 1993.
- 72 Whitcomb, C., Cervi, M., *Air Independent Propulsion (AIP) System Evaluation (U)*, NSWC Carderock, Bethesda MD, Report Number NSWC/SSD-93-17, June 1993.
- 73 Whitcomb, C., Price, S., Submarine, Special Warfare Submarine Design Project, Course 13.414, Ocean Engineering Department, Massachusetts Institute of Technology, May 1992.
- 74 Wilson, M. S., et al, *Electrocatalysis Issues in Polymer Electrolyte Fuel Cells*, Proceedings of the 28th Intersociety Energy Conversion Engineering Conference, Vol.1, Atlanta, GA, 1993.

(Blank Reverse)

APPENDIX A

POWER SOURCE DOCUMENTATION

A.0 OVERVIEW

This appendix contains supporting data and calculations for the energy conversion devices and batteries discussed in Chapter 4, and modeled in Chapter 6. Material properties are taken from References [32,48].

	<u>Section</u>	<u>Page No.</u>
A.1	Summary of Energy Conversion Devices	148
A.2	Proton Exchange Membrane Fuel Cell (PEM)	149
A.3	Molten Carbonate Fuel Cell (MCFC)	150
A.4	Aluminum-Oxygen Semi-Cell (Aluminum)	152
A.5	Closed Cycle Diesel (CCD)	153
A.6	Stirling Engines	155
A.7	Closed Brayton Cycle (CBC)	157
A.8	Lead Acid Battery	158
A.9	Nickel-Cadmium Battery (Ni/Cd)	159
A.10	Lithium-Aluminum / Iron-Sulfide Battery (LAIS)	161

A.1 SUMMARY OF ENERGY CONVERSION DEVICES

Table A.1

Summary of Energy Conversion Devices

AIP Plant Attribute	PEM	MCFC	ALOX	CCD	STIRLING	CBC
Plant Weight (kg/kW)	18.0	24.6	55.33	11.7	11.54	4.0
Plant Volume (ft ³ /kW)	0.343	1.08	3.5	0.389	0.487	0.151
Reformer Weight (kg/kW)	18.0	---	---	---	---	---
Reformer Volume (ft ³ /kW)	0.424	---	---	---	---	---
Oxidant Weight (kg/kW _{hr})	0.511	0.554	0.263	0.988	1.0	0.872
Oxidant Volume (ft ³ /kW _{hr})	0.016	0.017	0.008	0.031	0.031	0.027
Fuel Weight (kg/kW _{hr})	METHANOL 0.34	DIESEL 0.165	ALUMINUM 0.28	DIESEL 0.247	DIESEL 0.26	DIESEL 0.195
Fuel Volume (ft ³ /kW _{hr})	0.015	0.007	0.000#	0.011	0.011	0.008
Other Weight (kg/kW _{hr})	COMP WATER 0.163	COMP WATER 0.177	KOH/ WATER 0.898	ARGON/ WATER 0.413	COMP WATER 0.319	COMP WATER 0.278
Other Volume (ft ³ /kW _{hr})	0.0176	0.0191	0.0318	0.0806	0.0345	0.03
Product Weight (kg/kW)	1.67	1.67	---	1.67	1.67	1.67
Product Volume (ft ³ /kW)	2.354	2.354	---	2.354	2.354	2.354

Fuel volume is included in plant volume.

A.2 PEM FUEL CELL

The following summarizes the weight and volume factors applied to the modeling of the PEM AIP plant.

	Type	Weight Factor (kg/**)	Volume Factor (ft ³ /**)	Volume Factor	Weight Factor
Plant type (** = kW)	PEM	18.0	0.343	1.0	1.0
Reformer (** = kW)	YES	18.0	0.424	1.0	1.0
Oxidant (** = kWhr)	LOX	0.511	0.016	1.46	3.0
Fuel (** = kWhr)	METHANOL	0.34	0.015	1.0	1.0
Other (** = kWhr)	COMP WATER	0.163	0.0176	2.3	1.0
Prod. Mgmt. (** = kW)	COS-WORTH	1.67	2.354	1.0	1.0

Plant weights and volumes, as well as reactant consumption rates were gathered from several sources.

Reference PEM	Efficiency	Weight Density (kg/kW)	Volume Density (ft ³ /kW)	Oxidant Rate (kg/kWhr)	Fuel Rate (kg/kWhr)	Remarks
12		15.87	1.0	0.403	0.05#	Sys. Effic.- H2 Sys. Effic.- Meth.
58	70%					
38	55%					
1		5.0	0.136	0.5	0.047#	Sys. Effic
70	60%	3.97	0.118			
13		18.53	0.338	0.62	0.35@	
40				0.511	.34@	
73				0.367	.046#	
72		13.6	1.1			
Average		11.394	0.538	0.480	---	
Assumed Value*		18.0	0.343	0.511	.34@ .064#	

*The assumed value includes the author's judgement of the validity of the source.

@ Methanol

Pure Hydrogen

Each reference was reviewed for its consistency with other sources and to evaluate the basis of how the data was presented. From the estimates of reactant consumption in kg/kWhr, the volumetric consumption rate was computed assuming a density for the form of the reactant. For the PEM plant with methanol and LOX:

Oxidant volume factor:

$$\left(0.511 \frac{\text{kg}}{\text{kWhr}}\right) \left(2.205 \frac{\text{lb}}{\text{kg}}\right) \left(0.014 \frac{\text{ft}^3}{\text{lb}}\right) = 0.016 \frac{\text{ft}^3}{\text{kWhr}}.$$

Fuel volume factor:

$$\left(0.34 \frac{\text{kg}}{\text{kWhr}}\right) \left(2.205 \frac{\text{lb}}{\text{kg}}\right) \left(0.020 \frac{\text{ft}^3}{\text{lb}}\right) = 0.015 \frac{\text{ft}^3}{\text{kWhr}}.$$

To allocate volumes for the compensating water tanks and the weight of the empty tank structure, the following factors were calculated using standard tank data from Reference [12]:

Compensating water volume:

$$\left(0.511 \frac{\text{kg}}{\text{kWhr}}\right) \left(2.205 \frac{\text{lb}}{\text{kg}}\right) \left(0.0156 \frac{\text{ft}^3}{\text{lb}}\right) = 0.0176 \frac{\text{ft}^3}{\text{kWhr}}.$$

Compensating water weight:

$$\left(0.511 \frac{\text{kg}}{\text{kWhr}}\right) \left(0.0156 \frac{\text{ft}^3}{\text{lb}}\right) \left(\frac{20.4 \text{ lb of tank}}{\text{ft}^3 \text{ of reactant}}\right) = 0.163 \frac{\text{kg}}{\text{kWhr}}.$$

Other fuel and oxidant options for the PEM plant are detailed in Appendix B. Reformer and product management estimates are contained in Appendix B.

A.3 MOLTEN CARBONATE FUEL CELL

The following summarizes the weight and volume factors applied to the modeling of the MCFC AIP plant.

	Type	Weight Factor (kg/**)	Volume Factor (ft ³ /**)	Volume Factor	Weight Factor
Plant type (** = kW)	MCFC	24.6	1.08	1.0	1.0
Reformer (** = kW)	NONE	0.0	0.0	---	---
Oxidant (** = kWhr)	LOX	0.554	0.017	1.46	3.0
Fuel (** = kWhr)	DIESEL	0.165	0.007	1.0	1.0
Other (** = kWhr)	COMP WATER	0.177	0.0191	2.3	1.0
Prod. Mgmt. (** = kW)	COS-WORTH	1.67	2.354	1.0	1.0

As before, plant weights, volumes, and reactant consumption rates were gathered from several sources.

Reference MCFC	Efficiency	Weight Density (kg/kW)	Volume Density (ft ³ /kW)	Oxidant Rate (kg/kWhr)	Fuel Rate (kg/kWhr)	Remarks
58	35%					System Effic. Cell Efficiency
38	65%	13.2		0.425	0.128	
60		18.2	0.82	0.683	0.199	
65		42.6	1.33	0.553	0.167	Cell Efficiency System Effic.
73	60%			0.485	0.14	
72	48%	27.2	1.3		0.381	
40				0.533	0.154	
Average		25.3	1.15	0.536	0.195	
Assumed Value*		24.6	1.08	0.554	0.165	

*The assumed value includes the author's judgement of the validity of the source.

Each reference was evaluated and the volumetric consumption rate computed assuming a density for the form of the reactant. For the MCFC plant with diesel fuel and LOX:

Oxidant volume factor:

$$\left(0.554 \frac{\text{kg}}{\text{kWhr}}\right) \left(2.205 \frac{\text{lb}}{\text{kg}}\right) \left(0.014 \frac{\text{ft}^3}{\text{lb}}\right) = 0.017 \frac{\text{ft}^3}{\text{kWhr}}$$

Fuel volume factor:

$$\left(0.165 \frac{\text{kg}}{\text{kWhr}}\right) \left(2.205 \frac{\text{lb}}{\text{kg}}\right) \left(0.019 \frac{\text{ft}^3}{\text{lb}}\right) = 0.007 \frac{\text{ft}^3}{\text{kWhr}}$$

Compensating water volume:

$$\left(0.554 \frac{\text{kg}}{\text{kWhr}}\right) \left(2.205 \frac{\text{lb}}{\text{kg}}\right) \left(0.0156 \frac{\text{ft}^3}{\text{lb}}\right) = 0.0191 \frac{\text{ft}^3}{\text{kWhr}}$$

Compensating water weight:

$$\left(0.554 \frac{\text{kg}}{\text{kWhr}}\right) \left(0.0156 \frac{\text{ft}^3}{\text{lb}}\right) \left(\frac{20.4 \text{ lb of tank}}{\text{ft}^3 \text{ of reactant}}\right) = 0.177 \frac{\text{kg}}{\text{kWhr}}$$

A.4 ALUMINUM OXYGEN SEMI-CELL

	Type	Weight Factor (kg/**)	Volume Factor (ft ³ /**)	Volume Factor	Weight Factor
Plant type (** = kW)	ALOX	55.3	3.5	1.0	1.0
Reformer (** = kW)	NONE	0.0	0.0	---	---
Oxidant (** = kWhr)	LOX	0.263	0.008	1.46	3.0
Fuel (** = kWhr)	ALUMINUM	0.28	0.0	1.0	1.0
Other (** = kWhr)	KOH/ WATER	0.898	0.0318	1.33	2.3
Prod. Mgmt. (** = kW)	NONE	0.0	0.0	---	---

The table above summarizes the weight and volume information gathered from several sources.

Reference ALOX	Efficiency	Weight Density (kg/kW)	Volume Density (ft ³ /kW)	Oxidant Rate (kg/kWhr)	Fuel Rate (kg/kWhr)	Remarks
12		55.33#	3.5	0.26	0.28	KOH + H ₂ O = 0.898kg/kWhr
72		86.2@	4.6			
13		117.3@		0.276		KOH + H ₂ O = 0.896kg/kWhr
40				0.263		
Average		---	4.05	0.266	0.280	KOH + H ₂ O = 0.898kg/kWhr
Assumed Value*		55.33#	3.50	0.263	0.280	

*The assumed value includes the author's judgement of the validity of the source.

without aluminum

@ includes aluminum in cell

Again, each reference was evaluated and the volumetric consumption rate computed assuming a density for the form of the reactant. For the Aluminum plant with LOX:

Oxidant volume factor:

$$\left(0.263 \frac{\text{kg}}{\text{kWhr}}\right) \left(2.205 \frac{\text{lb}}{\text{kg}}\right) \left(0.014 \frac{\text{ft}^3}{\text{lb}}\right) = 0.008 \frac{\text{ft}^3}{\text{kWhr}}$$

No fuel volume factor was computed because the plant volume factor already includes the aluminum fuel. No compensating water factors were determined because the products are retained on board.

A.5 CCD ENGINES

The following summarizes the weight and volume factors applied to the modeling of the CCD AIP plant.

	Type	Weight Factor (kg/**)	Volume Factor (ft ³ /**)	Volume Factor	Weight Factor
Plant type (** = kW)	CCD	11.7	0.389	1.0	1.0
Reformer (** = kW)	NONE	0.0	0.0	---	---
Oxidant (** = kWhr)	LOX	0.988	0.031	1.46	3.0
Fuel (** = kWhr)	DIESEL	0.247	0.011	1.0	1.0
Other (** = kWhr)	ARGON/WATER	0.413	0.0806	1.0	1.0
Prod. Mgmt. (** = kW)	COS-WORTH	1.67	2.354	1.0	1.0

Plant weights and volumes, as well as reactant consumption rates were gathered from several sources.

Reference CCD	Efficiency	Weight Density (kg/kW)	Volume Density (ft ³ /kW)	Oxidant Rate (kg/kWhr)	Fuel Rate (kg/kWhr)	Remarks
38	30%					System Effic. Ar-0.038 kg/kWhr System Effic. System Effic.
1		5.88	0.25	1.0	0.3	
47		18.4	3.57	0.985	0.28	
70		10.6	0.63		0.284	
65		6.1	0.388	1.14	0.187	
29				0.84	0.24	
73	33%			0.873	0.252	
72	33%	18.14	1.0			
40				0.642	0.185	
Average		11.8	1.118	0.913	0.247	
Assumed Value*		11.7	0.389	0.988	0.247	

*The assumed value includes the author's judgement of the validity of the source.

The volumetric consumption rate was computed assuming a density for the form of the reactant. For the CCD plant with diesel fuel and LOX:

Oxidant volume factor:

$$\left(0.988 \frac{\text{kg}}{\text{kWhr}}\right) \left(2.205 \frac{\text{lb}}{\text{kg}}\right) \left(0.014 \frac{\text{ft}^3}{\text{lb}}\right) = 0.031 \frac{\text{ft}^3}{\text{kWhr}}.$$

Fuel volume factor:

$$\left(0.247 \frac{\text{kg}}{\text{kWhr}}\right) \left(2.205 \frac{\text{lb}}{\text{kg}}\right) \left(0.019 \frac{\text{ft}^3}{\text{lb}}\right) = 0.011 \frac{\text{ft}^3}{\text{kWhr}}.$$

Argon volume factor:

$$\left(0.038 \frac{\text{kg}}{\text{kWhr}}\right) \left(0.6165 \frac{\text{m}^3}{\text{kg}}\right) \left(3.281 \frac{\text{ft}}{\text{m}}\right)^3 = 0.827 \frac{\text{ft}^3}{\text{kWhr}}.$$

The Argon weight and volume factors are combined with the compensating water factors for entry into the "other" reactant category of the model:

$$\text{Argon volume: } \left(0.827 \frac{\text{ft}^3}{\text{kWhr}}\right) (0.00274) = 0.00227 \frac{\text{ft}^3}{\text{kWhr}}.$$

$$\text{Argon weight: } \left(0.038 \frac{\text{kg}}{\text{kWhr}}\right) (2.6) = 0.0988 \frac{\text{kg}}{\text{kWhr}}.$$

$$\text{Comp. water volume: } \left(0.988 \frac{\text{kg}}{\text{kWhr}}\right) \left(2.205 \frac{\text{lb}}{\text{kg}}\right) \left(0.0156 \frac{\text{ft}^3}{\text{lb}}\right) (2.3) = 0.078 \frac{\text{ft}^3}{\text{kWhr}}.$$

$$\text{Comp. water weight: } \left(0.988 \frac{\text{kg}}{\text{kWhr}}\right) \left(0.0156 \frac{\text{ft}^3}{\text{lb}}\right) \left(\frac{20.4 \text{ lb of tank}}{\text{ft}^3 \text{ of reactant}}\right) = 0.314 \frac{\text{kg}}{\text{kWhr}}.$$

Combined volume: $0.00227 + 0.078 = 0.0806 \frac{\text{ft}^3}{\text{kWhr}}$.

Combined weight: $0.0988 + 0.314 = 0.413 \frac{\text{kg}}{\text{kWhr}}$.

Because argon and compensating water are combined, volume and weight factors are applied before the two are added. See Appendix B for argon weight and volume factors.

A.6 STIRLING ENGINES

The following summarizes the weight and volume factors applied to the modeling of the Stirling AIP plant.

	Type	Weight Factor (kg/**)	Volume Factor (ft ³ /**)	Volume Factor	Weight Factor
Plant type (** = kW)	STIRLING	11.54	0.487	1.0	1.5
Reformer (** = kW)	NONE	0.0	0.0	---	---
Oxidant (** = kWhr)	LOX	1.0	0.031	1.46	3.0
Fuel (** = kWhr)	DIESEL	0.26	0.011	1.0	1.0
Other (** = kWhr)	COMP WATER	0.319	0.0345	2.3	1.0
Prod. Mgmt. (** = kW)	COS-WORTH	1.67	2.354	1.0	1.0

The following plant weights and volumes and reactant consumption rates were gathered from several sources.

Reference STIRLING	Efficiency	Weight Density (kg/kW)	Volume Density (ft ³ /kW)	Oxidant Rate (kg/kW-hr)	Fuel Rate (kg/kW-hr)	Remarks
1	39%	8	0.353	1.0	0.3	System Effic. 65kW per engine
30						
17		11.54	0.487	0.95	0.199	
64				0.949	0.26	
65		11.8	0.7	1.07	0.175	
40				0.836	0.241	
Average		10.45	0.513	0.961	0.235	
Assumed Value*		11.54	0.487#	1.000	0.260	

*The assumed value includes the author's judgement of the validity of the source.

#Volume packing factor of 1.5 applied in model due to data uncertainty.

The following volumetric consumption rates for the Stirling plant with diesel fuel and LOX were computed assuming a density for the form of the reactant:

Oxidant volume factor:

$$\left(1.0 \frac{\text{kg}}{\text{kW-hr}}\right) \left(2.205 \frac{\text{lb}}{\text{kg}}\right) \left(0.014 \frac{\text{ft}^3}{\text{lb}}\right) = 0.031 \frac{\text{ft}^3}{\text{kW-hr}}.$$

Fuel volume factor:

$$\left(0.26 \frac{\text{kg}}{\text{kW-hr}}\right) \left(2.205 \frac{\text{lb}}{\text{kg}}\right) \left(0.019 \frac{\text{ft}^3}{\text{lb}}\right) = 0.011 \frac{\text{ft}^3}{\text{kW-hr}}.$$

Compensating water volume:

$$\left(1.0 \frac{\text{kg}}{\text{kW-hr}}\right) \left(2.205 \frac{\text{lb}}{\text{kg}}\right) \left(0.0156 \frac{\text{ft}^3}{\text{lb}}\right) = 0.0345 \frac{\text{ft}^3}{\text{kW-hr}}.$$

Compensating water weight:

$$\left(1.0 \frac{\text{kg}}{\text{kW-hr}}\right) \left(0.0156 \frac{\text{ft}^3}{\text{lb}}\right) \left(\frac{20.4 \text{ lb of tank}}{\text{ft}^3 \text{ of reactant}}\right) = 0.319 \frac{\text{kg}}{\text{kW-hr}}.$$

Because of the uncertainty of the data collected for the Stirling engine and its auxiliaries, a plant volume packing factor of 1.5 was assumed.

A.7 CBC ENGINES

The following summarizes the weight and volume factors applied to the modeling of the CBC AIP plant.

	Type	Weight Factor (kg/**)	Volume Factor (ft ³ /**)	Volume Factor	Weight Factor
Plant type (** = kW)	CBC	4.0	0.151	1.0	1.0
Reformer (** = kW)	NONE	0.0	0.0	---	---
Oxidant (** = kWhr)	LOX	0.872	0.027	1.46	3.0
Fuel (** = kWhr)	DIESEL	0.195	0.008	1.0	1.0
Other (** = kWhr)	COMP WATER	0.278	0.03	2.3	1.0
Prod. Mgmt. (** = kW)	COS-WORTH	1.67	2.354	1.0	1.0

The plant weights, volumes and reactant consumption rates gathered from several sources are:

Reference CBC	Efficiency	Weight Density (kg/kW)	Volume Density (ft ³ /kW)	Oxidant Rate (kg/kWhr)	Fuel Rate (kg/kWhr)	Remarks
12	40-50%	4.54	0.12	1.51	0.218	System Effic. System Effic.
69						
70		2.95	0.16			
65		4.59	0.173	1.06	0.378	
2		5.49	0.175			
40				0.906	0.261	
Average		4.39	0.157	1.159	0.286	
Assumed Value*		4.0	0.151	0.872	0.195	

*The assumed value includes the author's judgement of the validity of the source.

The volumetric consumption rates were computed assuming a density for the form of the reactant. For the CBC plant with diesel fuel and LOX:

Oxidant volume factor:

$$\left(0.872 \frac{\text{kg}}{\text{kWhr}}\right)\left(2.205 \frac{\text{lb}}{\text{kg}}\right)\left(0.014 \frac{\text{ft}^3}{\text{lb}}\right) = 0.027 \frac{\text{ft}^3}{\text{kWhr}}.$$

Fuel volume factor:

$$\left(0.195 \frac{\text{kg}}{\text{kWhr}}\right)\left(2.205 \frac{\text{lb}}{\text{kg}}\right)\left(0.019 \frac{\text{ft}^3}{\text{lb}}\right) = 0.008 \frac{\text{ft}^3}{\text{kWhr}}.$$

Compensating water volume:

$$\left(0.872 \frac{\text{kg}}{\text{kWhr}}\right)\left(2.205 \frac{\text{lb}}{\text{kg}}\right)\left(0.0156 \frac{\text{ft}^3}{\text{lb}}\right) = 0.03 \frac{\text{ft}^3}{\text{kWhr}}.$$

Compensating water weight:

$$\left(0.872 \frac{\text{kg}}{\text{kWhr}}\right)\left(0.0156 \frac{\text{ft}^3}{\text{lb}}\right)\left(\frac{20.4 \text{ lb of tank}}{\text{ft}^3 \text{ of reactant}}\right) = 0.278 \frac{\text{kg}}{\text{kWhr}}.$$

A.8 LEAD ACID BATTERY

The data taken is the same used in the baseline submarine battery determination in Appendix C, with the final results repeated here for ease in comparison to other battery types:

LEAD ACID BATTERY DATA

2 hour capacity (kW-hr)	1600
5 hour capacity (kW-hr)	2035
80+ hour capacity (kW-hr)	2645.5
Weight (ltons)	76.4
Volume (ft ³)	800
No. Batteries Burst	5.51
No. Batteries Creep	5.08
Coulombic Efficiency	0.9

A.9 Ni/Cd BATTERY

For comparison purposes, the lead acid battery was developed based on a standard battery unit having a nominal total voltage of 240 VDC. A standard Ni/Cd battery will be determined based on the same total battery voltage.

The following summarizes data sources and their estimates for weights, volumes and battery capacity:

Reference Ni/Cd	Efficiency	Energy Density (kWh/ft ³)	Energy Density (Wh/lb)	Remarks
71		1.72	13.57	5000 A, 231 VDC @ 1 hour rate @ 1 hour rate
4		1.8	15.0	
Average		1.76	14.29	
Assumed Value*	90%	1.8	15	

*The assumed value includes the author's judgment of the validity of the source.

As a result a standard Ni/Cd battery is determined to have the following characteristics:

$$1 \text{ hr capacity: } (5000 \text{ Amphr})(231\text{V}) = 1155 \text{ kWhr}$$

$$\text{Weight: } \left(\frac{1155 \text{ kWhr}}{15 \frac{\text{Whr}}{\text{lb}}} \right) \left(\frac{1000 \text{ Whr}}{\text{kWhr}} \right) \left(\frac{\text{ton}}{2240 \text{ lb}} \right) = 34.38 \text{ tons}$$

$$\text{Volume: } \left(\frac{1155 \text{ kWhr}}{1.8 \frac{\text{Whr}}{\text{ft}^3}} \right) = 642 \text{ ft}^3$$

Reference [23] gives the following figure for Ni/Cd battery capacities other than a standard 1-hour (1C) rate:

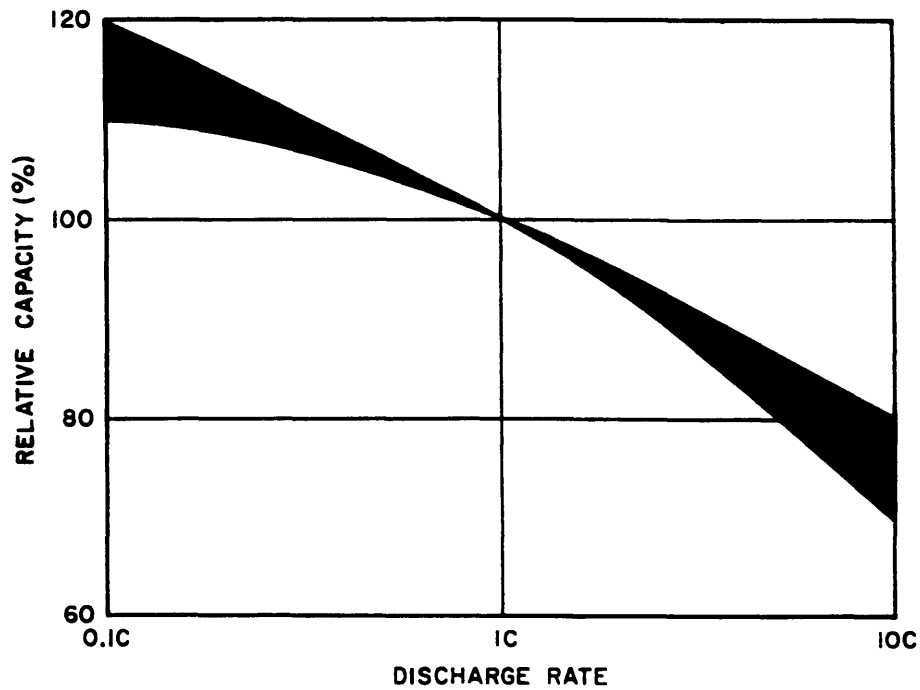

Ni/Cd Capacity vs. Discharge Rate

Figure A.1

From this figure, the following scaling factors for battery capacity are assumed:

	<u>factor</u>	<u>Capacity</u>
1 hour rate	1.0	1155 kW-hr
2 hour rate (% of 1 hour rate)	1.04	1201 kW-hr
80+ hour rate (% of 1 hour rate)	1.1	1270 kW-hr

Using the required energy required for a 4 knot, 90 hour transit and 20 knot, 2 hour burst from Appendix C, the following number of standard batteries are required:

$$\frac{8814 \text{ kW-hr}}{1201 \frac{\text{kW-hr}}{\text{Battery}}} = 7.34 \text{ Batteries (burst)}$$

$$\frac{13692 \text{ kW-hr}}{1270 \frac{\text{kW-hr}}{\text{Battery}}} = 10.78 \text{ Batteries (creep)}$$

SUMMARY OF Ni/Cd BATTERY DATA

1 hour capacity (kW-hr)	1155
2 hour capacity (kW-hr)	1201
80+ hour capacity (kW-hr)	1270
Weight (ltons)	38
Volume (ft ³)	670
No. Batteries Burst	7.34
No. Batteries Creep	10.78
Coulombic Efficiency	0.9

A.10 LAIS BATTERY

The standard LAIS battery will be determined based on a total battery voltage of 240VDC.

From the data presented on the next sheet, a standard LAIS battery is determined to have the following characteristics:

$$\frac{240 \text{ Volts}}{24 \frac{\text{Volts}}{\text{Cell}}} = (10 \text{ Cells}) \left(\frac{45 \text{ kWhr}}{\text{Cell}} \right) = 450 \text{ kWhr}$$

$$\text{Weight : } \left(\frac{450 \text{ kWhr}}{120 \frac{\text{Wh}}{\text{Wh}}} \right) \left(\frac{1000 \text{ Wh}}{\text{kWhr}} \right) \left(\frac{2.205 \text{ lb}}{\text{kg}} \right) \left(\frac{\text{ltons}}{2240 \text{ lb}} \right) = 3.69 \text{ ltons}$$

$$\text{Volume : } \left(\frac{450 \text{ kWhr}}{220 \frac{\text{Wh}}{\text{Wh}}} \right) \left(\frac{1000 \text{ Wh}}{\text{kWhr}} \right) \left(\frac{\text{m}^3}{1000 \text{ l}} \right) \left(\frac{\text{ft}}{0.3048 \text{ m}} \right)^3 = 72.24 \text{ ft}^3$$

The following summarizes data sources and their estimates for weights, volumes and battery capacity:

Reference LAIS	Efficiency	Energy Density (Wh/l)	Energy Density (Wh/kg)	Remarks
58		200		45 kWhr at 24 VDC
43	100%	350	130	
10		122	70.56	
15		160	190	
4				
Average		208	130.19	
Assumed Value*		220	120	

*The assumed value includes the author's judgment of the validity of the source.

Because the LAIS battery is projected to have similar discharge characteristics to the lead acid battery the following scaling factors are assumed:

	<u>factor</u>	<u>Capacity</u>
5 hour rate	1.0	450kW-hr
2 hour rate (% of 5 hour rate)	0.83	369 kW-hr
80+ hour rate (% of 5 hour rate)	1.3	858 kW-hr

Using the required energy required for a 4 knot, 90 hour transit and 20 knot, 2 hour burst from Appendix C, the following number of standard batteries are required:

$$\frac{8814 \text{ kWhr}}{369 \frac{\text{kWhr}}{\text{Battery}}} = 23.89 \text{ Batteries (burst)}$$

$$\frac{13692 \text{ kWhr}}{585 \frac{\text{kWhr}}{\text{Battery}}} = 23.41 \text{ Batteries (creep)}$$

SUMMARY OF LAIS BATTERY DATA

2 hour capacity (kW-hr)	369
5 hour capacity (kW-hr)	450
80+ hour capacity (kW-hr)	858
Weight (ltons)	3.69
Volume (ft ³)	72.24
No. Batteries Burst	23.89
No. Batteries Creep	23.41
Coulombic Efficiency	1.0

APPENDIX B

REACTANT DOCUMENTATION

B.0 OVERVIEW

This appendix contains supporting data and calculations for the reactants and discussed in Chapter 5, and modeled in Chapter 6. Material properties taken from References [32,48].

	<u>Section</u>	<u>Page No.</u>
B.1	Summary of reactant packing factors	164
B.2	Reformer	164
B.3	Exhaust Product Management	165
B.4	Oxidants	167
B.4.1	Liquid Oxygen (LOX)	167
B.4.2	Gaseous Oxygen	169
B.4.3	High Test Hydrogen Peroxide (HTP)	170
B.4.4	Sodium Perchlorate	170
B.5	Hydrogen	171
B.5.1	Liquid Hydrogen	171
B.5.2	Gaseous Hydrogen	172
B.5.3	Metal Hydride	172
B.6	Other Fuels	173
B.7	Other Reactants	173

B.1 SUMMARY OF REACTANT PACKING FACTORS

Table B.1
Reactant Packing Factors

Reactant	Weight Packing Factor	Volume Packing Factor
Liquid Oxygen	1.46	3.0
Gaseous Oxygen - Int.	4.96	3.84
Gaseous Oxygen - Ext.	4.96	1.28
High Test Peroxide -70%	1.0	1.0
Sodium Perchlorate	1.34	2.3
Liquid Hydrogen	11.0	3.0
Gaseous Hydrogen	65.0	1.28
Metal Hydride	50.0	1.0
Diesel Fuel	1.0	1.0
Methanol	1.0	1.0
Aluminum	Included in cells	Included in cells
Argon	2.6	0.00274
KOH/Water	1.33	2.3
Compensating Water	Incl. in Wt. Fac.	2.3

B.2 REFORMER

A reformer is required for any energy conversion device requiring pure hydrogen if the fuel not supplied in a pure form. Of the AIP plants considered, only the PEM cell may require a reformer. As discussed in Chapter 5, the reformer decomposes a hydrogen based fuel to produce hydrogen gas, usually through the use of steam generated by the fuel being reformed. Methanol was the reformed fuel used in this model, but diesel as well as other fuels could be used instead. Reference [3] gives the following volumes for reformers:

$$\text{Methanol: } 0.012 \frac{\text{m}^3}{\text{kW}} \left(0.424 \frac{\text{ft}^3}{\text{kW}} \right)$$

Diesel: $0.043 \frac{\text{m}^3}{\text{kW}} \left(1.52 \frac{\text{ft}^3}{\text{kW}} \right).$

While no weight was given, a weight density equal to the PEM cell (18 kg/kW) is assumed. Because the reformer is a relatively compact item, no penalty, i.e. a packing factor equal to one, is assumed for equipment arrangement.

B.3 EXHAUST PRODUCT MANAGEMENT

Whether reformed or burned directly by the AIP plant, fuels such as methanol and diesel will produce CO₂ and other gasses as a by-product. For this model, overboard discharge is assumed by the use of the Cosworth system, Section 5.3. Reference [29] gives the following weights and volumes for such a system:

Weight: $1.67 \frac{\text{kg}}{\text{kW}}$

Volume: $2.354 \frac{\text{ft}^3}{\text{kW}}.$

The discharge of gas overboard requires significant energy to raise the CO₂ gas pressure to that of the ocean. Assuming a 500 kW PEM plant with methanol, operating at a 400 ft. depth:

governing reaction:

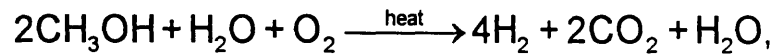

CO₂ production:

$$\left(0.34 \frac{\text{kg}}{\text{kWhr}} \right) (500 \text{ kW}) \left(\frac{44 \frac{\text{g}}{\text{mole}} \text{ CO}_2}{32 \frac{\text{g}}{\text{mole}} \text{ CH}_3\text{OH}} \right) = 233.75 \frac{\text{kg} - \text{CO}_2}{\text{hr}},$$

ocean back pressure at a depth of 400 ft:

$$(400 \text{ feet})\left(\frac{44 \text{ psi}}{100 \text{ feet of depth}}\right) + 14.7 \text{ psia} = 190.7 \text{ psia.}$$

Assuming an ideal gas with $\gamma = 1.33$, initial temperature of 300°K and 14.7 psia :

$$\left(\frac{T_2}{T_1}\right) = \left(\frac{P_2}{P_1}\right)^{\frac{\gamma-1}{\gamma}} \Rightarrow T_2 = (300^\circ\text{K})\left(\frac{190.7 \text{ psia}}{14.7 \text{ psia}}\right)^{\frac{1.33-1}{1.33}} = 566.6^\circ\text{K,}$$

the change in enthalpy for CO_2 is [32]:

$$\text{At } 566^\circ\text{K: } h_{\text{CO}_2} = 2.720 \frac{\text{kcal}}{\text{mole}}$$

$$\text{At } 300^\circ\text{K: } -h_{\text{CO}_2} = 0.016 \frac{\text{kcal}}{\text{mole}}$$

$$\Delta h_{\text{CO}_2} = 2.704 \frac{\text{kcal}}{\text{mole}}.$$

Assuming a compressor efficiency of 0.80, the work required to compress the gas is

$$\left(\frac{2.704 \frac{\text{kcal}}{\text{mole}}}{0.8}\right)\left(\frac{\text{moleCO}_2}{44\text{g}}\right)\left(\frac{1000\text{g}}{\text{kg}}\right)\left(\frac{4.184 \frac{\text{J}}{\text{kg}}}{\frac{\text{cal}}{\text{g}}}\right) = 3.21\text{e}^5 \frac{\text{J}}{\text{kg}},$$

$$(3.21\text{e}^2 \frac{\text{kJ}}{\text{kg}})\left(233.75 \frac{\text{kgCO}_2}{\text{hr}}\right)\left(\frac{\text{hr}}{3600\text{s}}\right) = 20.9 \frac{\text{kJ}}{\text{s}} \{\text{kW}\},$$

which amounts to 4.2 percent of the AIP plant output. Fuel consumption rates for AIP plants include this penalty.

The other major by-product of fuel cells is pure water, which is assumed to be stored on board for consumption or transferred to the variable ballast system.

B.4 OXIDANTS

B.4.1 LIQUID OXYGEN

In the model, LOX was assumed to be stored inside the pressure hull in an arrangement similar to Figure B.1. If the "oxygen compartment" takes up one half the cross-section of a 31 ft. diameter hull, and the external diameter of each LOX tank is 12 ft., then the ratio of area "A" to the total cross-section of the LOX tanks is:

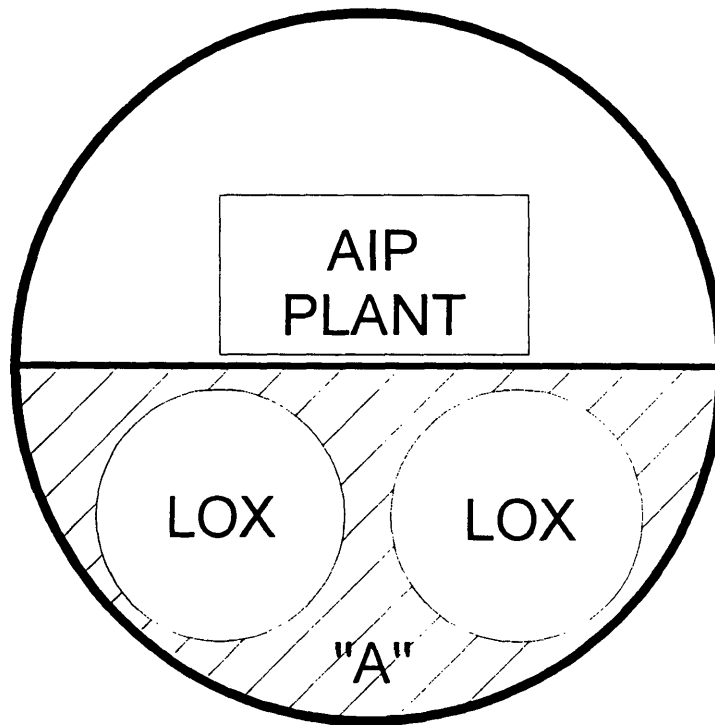

Liquid Oxygen Tank Arrangement

Figure B.1

$$\text{Area "A":} \quad \frac{1}{2} \left(\frac{\pi (31)^2}{4} \right) = 754.8 \text{ ft}^2$$

$$\text{Area of LOX tanks } 2\left(\frac{\pi (12)^2}{4}\right) = 226.2 \text{ ft}^2$$

$$\text{Ratio of areas: } \frac{754.8}{226.2} = 1.67.$$

Reference [73] gives a factor for the ratio of the outside LOX tank volume to LOX weight as $0.024 \frac{\text{ft}^3 \text{ of external tank}}{\text{lb of LOX}}$ and LOX tank weight to LOX weight as $0.46 \frac{\text{lb of LOX tank}}{\text{lb of LOX}}$. Reference [70] gives this ratio of weights as 1.25. For weights, a ratio of 1.46 is assumed. For the ratio of LOX tank to actual LOX volume, the result is:

$$\left(0.024 \frac{\text{ft}^3 \text{ of external tank}}{\text{lb of LOX}}\right)\left(71.23 \frac{\text{lb of LOX}}{\text{ft}^3 \text{ of LOX}}\right) = 1.71.$$

Combining these two factors, the overall volume packing factor for LOX becomes:

$$(1.71)(1.67) = 2.85.$$

Reference[64] suggests a factor of 3.37 while reference[12] suggests a factor of 3.0. The value of 3.0 is assumed.

In addition to the ship endurance requirements for oxygen, the breathing oxygen for the crew is added to the AIP requirement, since an AIP submarine may not be exchanging air with the atmosphere for weeks at a time. The following factors for breathing oxygen from reference [7] are assumed:

<u>Factor</u>	<u>Value</u>
Use rate of LOX	0.03 ft ³ /man-day
LOX density	71.23 lb/ft ³
Ullage	0.95
Factor of Safety	1.1

For a crew size of 44 and a mission length of 60 days:

cubic feet of LOX:

$$\left(0.03 \frac{\text{ft}^3}{\text{man-day}}\right)(44 \text{ men})(60 \text{ days})(1.05)(1.1) = 91.71 \text{ ft}^3,$$

tons of LOX:

$$\left(71.23 \frac{\text{lb}}{\text{ft}^3}\right)(91.71 \text{ ft}^3)\left(\frac{\text{ttons}}{2240 \text{ lb}}\right) = 2.92 \text{ ttons}.$$

This total is added to the total LOX for AIP endurance before the volume and weight packing factors are applied. For applications where LOX was not specified as the AIP oxidant, LOX was still assumed for breathing with packing factors applied.

B.4.2 GASEOUS OXYGEN

The storage of oxygen as a gas was assumed to be in high pressure cylinders at 3000 psi. The volumetric consumption of oxygen, based on the specific oxygen consumption of the PEM cell in Appendix A is

$$\left(0.511 \frac{\text{kg}}{\text{kWhr}}\right)\left(2.205 \frac{\text{lb}}{\text{kg}}\right)\left(0.059 \frac{\text{ft}^3}{\text{lb}}\right) = 0.066 \frac{\text{ft}^3}{\text{kWhr}},$$

and is used in the oxidant storage method comparison.

Reference [65] gives the following factors for tank weight and volume:

<u>Ratio</u>	<u>Factor</u>
Wt. Tank + Oxygen / Wt. Oxygen	4.96
Vol. Tank + Oxygen / Vol. Oxygen	1.28.

This storage of oxygen could be either internal or external to the pressure hull. An internal area analysis similar to the LOX case in Section B.4.1 gives a ratio of gas cylinder cross-section to area "A" of 3.0, and when multiplied by the volume factor above, a final packing factor of 3.84 is obtained. If the cylinders are stored outside the pressure hull, i.e. in a main ballast tank, then 100 percent

utilization of the area around the cylinders is assumed and the factor of 1.28 alone is applied. The weight factor of 4.96 is assumed to include the weight of the tank supports.

B.4.3 HIGH TEST PEROXIDE

HTP (70 percent) contains 33 w/o oxygen and is the concentration assumed in the model. At this concentration HTP is considered to be "safe" to handle with care. HTP decomposes by:

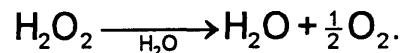

For 70 percent HTP, there are 2.06 moles of H_2O_2 , and also O, per 100 grams of solution. Therefore, based on the specific oxygen consumption of the PEM cell, the volumetric consumption of HTP is:

$$\left(0.511 \frac{\text{kg}}{\text{kWhr}}\right) \left(\frac{100 \text{ grams H}_2\text{O}_2}{[2.06 \text{ moles}][15.994 \frac{\text{grams}}{\text{mole of O}}]} \right) \left(0.012 \frac{\text{ft}^3}{\text{lb of H}_2\text{O}_2}\right) \left(2.205 \frac{\text{lb}}{\text{kg}}\right) = 0.0399 \frac{\text{ft}^3}{\text{kWhr}}.$$

Storage of HTP is assumed to be in plastic bladders in self compensating tanks external to the pressure hull with 100 percent utilization of the space, resulting in a packing factor of 1.0 for weight and volume.

B.4.4 SODIUM PERCHLORATE

The storage of sodium perchlorate is modeled as contained in pressure vessels, similar in construction to other steel tanks found onboard a submarine, and containing approximately 39 w/o Oxygen. Assuming the specific oxygen consumption rate for the PEM cell, the volumetric rate is:

$$\left(0.511 \frac{\text{kg Ox}}{\text{kWhr}}\right) \left(2.56 \frac{\text{kg NaClO}_4}{\text{kg Ox}}\right) \left(0.4 \frac{\text{ml}}{\text{g}}\right) \left(1000 \frac{\text{g}}{\text{kg}}\right) \left(0.061 \frac{\text{in}^3}{\text{ml}}\right) \left(0.083 \frac{\text{ft}}{\text{in}}\right)^3 = 0.0186 \frac{\text{ft}^3}{\text{kWhr}}.$$

Reference [12] gives the following standard tank factors for volume and weight:

<u>Ratio</u>	<u>Factor</u>
lb of tank / ft ³ of reactant	20.4
ft ³ of arrangeable tank volume / ft ³ of reactant	2.3.

For weight, the tank factor now becomes:

$$(1 \text{ kg Ox}) \left(2.56 \frac{\text{kg NaClO}_4}{\text{kg Ox}} \right) \left(400 \frac{\text{ml}}{\text{kg}} \right) \left(3.53 \times 10^{-5} \frac{\text{ft}^3}{\text{ml}} \right) \left(20.4 \frac{\text{lb tank}}{\text{ft}^3 \text{ reactant}} \right) \left(0.454 \frac{\text{kg tank}}{\text{lb tank}} \right) = 0.336 \text{ kg tank,}$$

factor = 1.34.

B.5 HYDROGEN

B.5.1 LIQUID HYDROGEN

Similar ideas apply to Liquid Hydrogen (LH) as they did to LOX, except that LH must be stored at a much colder temperature so the insulation will probably be thicker, and that LH requires more volume to store a given weight of reactant.

First the specific consumption of pure hydrogen must be calculated. Assuming the methanol flow rate for the PEM cell and the following reaction:

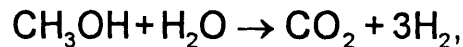

specific H₂ consumption:

$$\left(0.34 \frac{\text{kg CH}_3\text{OH}}{\text{kWhr}} \right) \left(\frac{6.048 \text{ grams H}_2}{32.0414 \text{ grams CH}_3\text{OH}} \right) = 0.064 \frac{\text{kg H}_2}{\text{kWhr}}.$$

To calculate the volumetric consumption:

$$\left(0.064 \frac{\text{kg}}{\text{kWhr}} \right) \left(14.1 \frac{\text{cm}^3}{\text{g}} \right) \left(1000 \frac{\text{g}}{\text{kg}} \right) \left(0.061 \frac{\text{g}}{\text{kg}} \right) \left(0.083 \frac{\text{ft}}{\text{in}} \right)^3 = 0.032 \frac{\text{ft}^3}{\text{kWhr}}.$$

Reference [73] gives the value of $0.043 \frac{\text{ft}^3}{\text{kWhr}}$, so an average value of $0.038 \frac{\text{ft}^3}{\text{kWhr}}$ is assumed. Reference [73] also gives a tank to hydrogen weight ratio of 10, thus a factor of 11 is assumed for the ratio of total tank plus LH weight to LH weight. The same volume packing factor that was used for LOX is assumed for LH.

B.5.2 GASEOUS HYDROGEN

The storage of hydrogen as a gas was assumed to be in high pressure cylinders at 3000 psi similar to the gaseous oxygen storage in Section B.4.2. A significant difference however involves the density of hydrogen which is much lower than for oxygen.

Assuming the specific hydrogen consumption rate of Section B.5.1, the volumetric consumption is:

$$\left(0.064 \frac{\text{kg}}{\text{kWhr}}\right) \left(2.205 \frac{\text{lb}}{\text{kg}}\right) \left(1 \frac{\text{ft}^3}{\text{lb}}\right) = 0.141 \frac{\text{ft}^3}{\text{kWhr}}.$$

Reference [57] gives a ratio of $90 \frac{\text{lb of H}_2 + \text{Tank}}{\text{lb of H}_2}$, while reference [73] gives $55.1 \frac{\text{lb of H}_2 + \text{Tank}}{\text{lb of H}_2}$. A value of 65 was assumed in the model. The storage cylinders are assumed to be similar in construction and arrangement to those for oxygen, except that due to safety considerations, only external storage was considered with a volume packing factor of 1.28.

B.5.3 METAL HYDRIDE

A regenerable metal hydride similar to the form FeTiMg was assumed. For an estimate of the volumetric consumption rate, the hydrogen consumption rate of Section B.5.1 was assumed and the following storage densities were considered:

<u>Reference</u>	<u>Storage density (ft³/lb)</u>
36	0.188
56	0.812
73	0.333
assumed value	0.4

resulting in:

$$\left(0.064 \frac{\text{kg}}{\text{kWhr}}\right)\left(0.4 \frac{\text{ft}^3}{\text{lb}}\right)\left(2.205 \frac{\text{lb}}{\text{kg}}\right) = 0.056 \frac{\text{ft}^3}{\text{kWhr}}.$$

The weight percent of hydrogen in a hydride is estimated by many sources to be between 1 and 3.5 w/o, depending on the storage medium [56]. For the model, a weight percent of 2.0 was assumed yielding a weight factor for hydride storage of 50. Because the volume estimate includes the storage medium, no additional volume penalty is required.

B.6 OTHER FUELS

The volume factors for other fuels were calculated in Appendix A with its particular AIP application. Methanol is immiscible in water, thus is stored in a seawater compensated tank external to the pressure hull, bladders similar to those used for HTP must be employed. In this case, the volume and weight packing factors are assumed to be 1.0 because 100 percent of the volume in the tank can be used and the tank weight is included as a part of the hull structure which scales with the size of the submarine. The same argument applies for diesel fuel except that bladders are not required because diesel fuel and water do not mix.

The weight and volume factors for aluminum are a default value of 1.0. While the specific aluminum consumption is computed, the volume is included in the size of the cell stacks, thus there is no additional weight or volume penalty.

B.7 OTHER REACTANTS

The storage of potassium hydroxide (KOH) and water for the aluminum cell is assumed to be in standard steel tanks, with typical internal arrangements. Using the tankage weight and volume ratios for Section B.4.4:

for a specific consumption rate for KOH/H₂O of $0.898 \frac{\text{kg}}{\text{kWhr}}$, the volumetric consumption rate is:

$$\left(0.898 \frac{\text{kg}}{\text{kWhr}}\right)\left(0.001 \frac{\text{m}^3}{\text{kg}}\right)\left(3.28 \frac{\text{ft}}{\text{m}}\right)^3 = 0.318 \frac{\text{ft}^3}{\text{kWhr}},$$

with a weight factor of:

$$\left(1\text{kg KOH} + \text{H}_2\text{O}\right)\left(0.001 \frac{\text{m}^3}{\text{kg}}\right)\left(3.28 \frac{\text{ft}}{\text{m}}\right)^3 \left(20.4 \frac{\text{lb tank}}{\text{ft}^3 \text{ reactant}}\right)\left(0.454 \frac{\text{kg tank}}{\text{lb tank}}\right) = 0.33 \text{ kg tank,}$$

factor = 1.33.

The volume packing factor is 2.3.

The only other fluid modeled is argon for the CCD engine. Reference [49] gives data for standard 2500 psi gas storage cylinders. For storage of 2700 m³ of gas at STP:

Tank weight	7000 kg
Tank external volume	7.4 m ³
Gas volume at STP:	2700 m ³

For a specific consumption rate for argon of $0.038 \frac{\text{kg}}{\text{kWhr}}$, the volumetric consumption rate is:

$$\left(0.038 \frac{\text{kg}}{\text{kWhr}}\right)\left(0.617 \frac{\text{m}^3}{\text{kg}}\right)\left(3.28 \frac{\text{ft}}{\text{m}}\right)^3 = 0.827 \frac{\text{ft}^3}{\text{kWhr}},$$

the weight factor is:

$$\left(1\text{kg Ar}\right)\left(0.617 \frac{\text{m}^3}{\text{kg}}\right)\left(3.28 \frac{\text{ft}}{\text{m}}\right)^3 \left(\frac{7000 \text{ kg of tank}}{2700 \text{ m}^3 \text{ of gas}}\right) = 1.6,$$

factor = 2.6,

and the volume packing factor is:

$$\left(\frac{7.4 \text{ m}^3 \text{ of tank}}{1700 \text{ m}^3 \text{ of gas}}\right) = 0.00274.$$

APPENDIX C

BASELINE DIESEL ELECTRIC SUBMARINE

C.0 INTRODUCTION

This appendix presents information on the baseline diesel electric submarine used as a basis for the AIP model in this thesis [68].

C.1	Baseline Submarine Summary	175
C.2	Propeller Selection Summary	175
C.3	Lead Acid Battery Selection	179
C.4	MIT Math Model for the Baseline Submarine	180

C.1 BASELINE SUBMARINE SUMMARY

Table C.1 gives specific details on the performance and characteristics of the baseline submarine with a profile view in Figure C.1.

C.2 PROPELLER SELECTION SUMMARY

The standard propeller chosen for the model was the same as selected for the Canadian Hybrid Submarine Design. This propeller was chosen by hand calculation, Figure C.2 and Table C.3, and validated using MANEUVERING TOOL software available from the US Navy Hydrodynamic Office through Draper Laboratory in Cambridge, MA. The general propeller characteristics are summarized in Table C.2

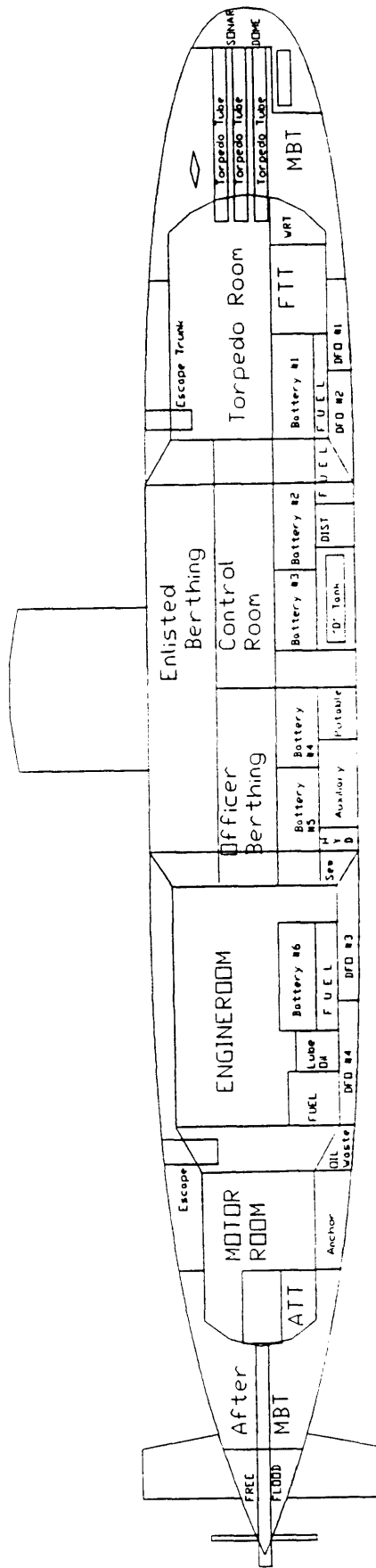

Profile View of the Baseline Submarine

Figure C.1

Table C.1
Baseline Diesel Electric Submarine

Characteristic		Value
Length		210 feet
Diameter		31 feet
Displacement	Surfaced	2325 Itons
	Submerged	2670 Itons
Diving Depth		900 feet
Range:	Snorting	10,000 nm
	Submerged @ 4 knots	96.5 hours
	Submerged @ max speed	2 hours
Maximum Submerged Speed		20 knots
Weapons	Number of Torpedo Tubes	6
	Number of Reloads	19
Crew		44
Endurance		90 days
Mobility:	Installed SHP	5000
	PC - 7 blade fixed pitch prop.	0.863
	3 - 12V 652 MB MTU Diesels	990 kWe each
	Lead Acid Battery: 2 hr Cap.	1600 kW-hr
	80+ hr Cap.	2645 kW-hr
	Volume	4408 ft ³
	Weight	421 Itons

Table C.2
Summary of Propeller Characteristics

Propeller Diameter	15.5 feet
Design Speed	20 knots
Hull Efficiency	1.27
Rotational Efficiency	1.03
Open Water Efficiency	0.66
Advance Coefficient	0.77
P/D Ratio	1.1
Propulsive Coefficient	0.862

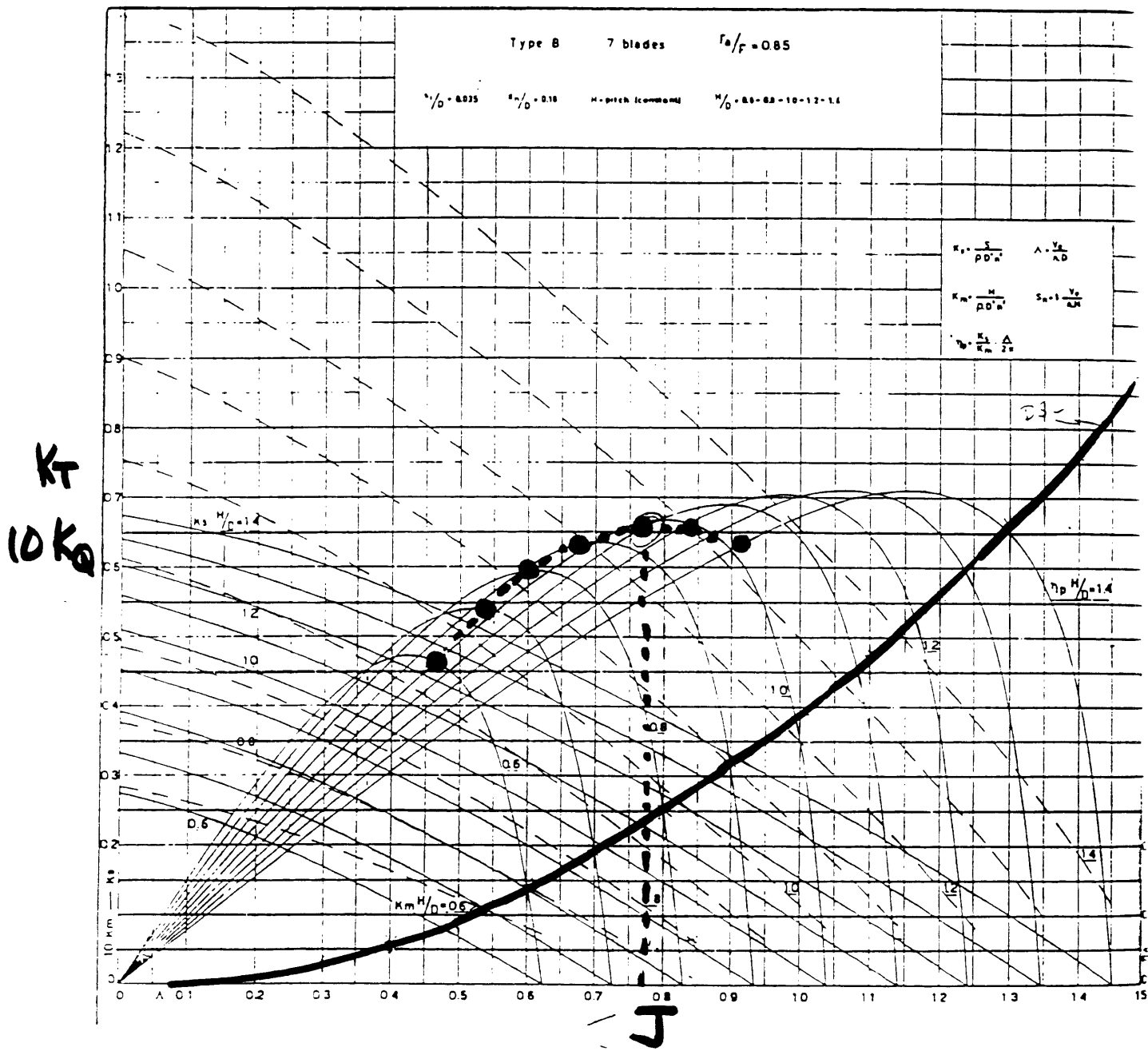

Propeller Curve, 7 Blade, Type B

Figure C.2

**Table C.3
Propeller Selection Spreadsheet**

	Hull Dia:	31		L/D-K2:	6.128
	EHP:	5000			
	Des Spd:	20 kts		EHP/V ³ :	0.129485
	density:	1.9905			
	Dp:	15.5			
	(1- ϕ):	0.91			
	(1-w):	0.72			
	eta h:	1.27			
	erttr:	1.03			
	J	Kt		Eta o:	0.66
	0.1	0.003179		@J:	0.77
	0.2	0.012717		P/D:	1.1
	0.3	0.028613			
	0.4	0.050868		PC:	0.862
	0.5	0.079481			
	0.6	0.114453			
	0.7	0.155783			
	0.8	0.203472			
	0.9	0.257519			
	1	0.317925			
	1.1	0.384689			
	1.2	0.457812			
	1.3	0.537293			
	1.4	0.623133			
	1.5	0.715331			

C.3 LEAD ACID BATTERY SELECTION

The Lead Acid Battery was sized according to the advanced lead acid battery data provided in References [4, 71]. The baseline submarine was determined to have the following propulsive plus hotel loads:

<u>Speed</u>	<u>Endurance</u>	<u>Energy Required</u>
4 knots	90 hours	13,692 kWhrs
20 knots	2 hours	8,814

A standard battery with a volume of 800 ft³ and a weight of 76.4 ltons was determined to have a capacity of 407 kW/hr at the 5 hour rate for a total energy

capacity of 2035 kWhrs. The following scaling factors were used to estimate the battery capacity at burst (2 hours) and creep (80+ hours) endurance rates:

	<u>factor</u>	<u>Capacity</u>
5 hour rate	1.0	2035 kWhr
2 hour rate	0.8 % of 5 hr rate	1628 kWhr
80+ hour rate	1.3 % of 5 hr rate	2645.5 kWhr

Dividing the capacities into the required energy above results in the following battery size:

<u>Endurance Requirement</u>	<u>Number of Batteries</u>
Burst	5.51
Creep	5.18

In order to meet both requirements, the larger battery was chosen, thus the total battery weight and volume is:

<u>Weight</u>	<u>Volume</u>
420.96 ltons	4408 ft ³

C.4 MIT MATH MODEL FOR THE BASELINE SUBMARINE

The MIT Math model, developed with MATHCAD 4.0 software by mathsoft follows. The model is self explanatory and employs the same methodology used in SUBSIZE.

MIT MATH MODEL - SS

Mode with increased battery 5/2/94

$$l_{\text{ton}} = 2240 \cdot \text{lb}$$

$$\text{hp} := \frac{33000 \cdot \text{ft} \cdot \text{lb}}{\text{min}} \quad \text{knt} := .515 \cdot \frac{\text{m}}{\text{sec}}$$

I. OWNER'S REQUIREMENTS (Enter the following owner's requirements)

Diving Depth (ft):	D _D := 900·ft	#
SHP:	SHP := 5000·hp	#
CREW Size:	N _T := 44	#
Range: (@10 knots snorting)	E := 10000·knt·hr	#
Stores Period:	T _S := 90	#
Number of Torpedo Tubes:	TT := 6	#
Number of Reloads:	RL := 19	#

II. VOLUME REQUIREMENTS

Using owner's requirements and Figs 1-3, determine the densities for Mobility, Tubes and Reloads for your Boat:

Mobility Density: $\rho_{\text{MOB}} = 6.7 \cdot \frac{\text{ft}^3}{\text{hp}}$ ##

Density/Tubes: $\rho_{\text{TT}} = \frac{1}{.0042} \cdot \text{ft}^3$ ##

Density/Reloads: $\rho_{\text{RL}} = \frac{1}{.0036} \cdot \text{ft}^3$ ##

MOBILITY: $V_{\text{MOB}} = \text{SHP} \cdot \rho_{\text{MOB}}$ $V_{\text{MOB}} = 3.35 \cdot 10^4 \cdot \text{ft}^3$

WEAPONS: $V_{\text{WEAPS}} = \text{TT} \cdot \rho_{\text{TT}} + \text{RL} \cdot \rho_{\text{RL}}$ $V_{\text{WEAPS}} = 6.706 \cdot 10^3 \cdot \text{ft}^3$

C³I: $V_{\text{C3I}} = 5300 \cdot \text{ft}^3$ $V_{\text{C3I}} = 5.3 \cdot 10^3 \cdot \text{ft}^3$

SHIP SUPPORT: Area Analysis - assume a 7' deck height and consider factors for passageway = 1.08 and hull curvature = 1.12

$$V_{\text{PH}} = 5.961 \cdot 10^4$$

Auxiliaries: $V_{\text{aux}} = .03 \cdot \text{ft}^3 \cdot V_{\text{PH}} + 9.3 \cdot \text{ft}^3 \cdot N_T$ $V_{\text{aux}} = 2.198 \cdot 10^3 \cdot \text{ft}^3$

Berth & Mess: $A_{\text{bm}} = 10 \cdot \text{ft}^2 \cdot N_T$ $A_{\text{bm}} = 440 \cdot \text{ft}^2$

Storerooms: $A_{\text{sr}} = 8.5 \cdot \text{ft}^2 \cdot T_S$ $A_{\text{sr}} = 765 \cdot \text{ft}^2$

Other Spaces: (offices, etc) $A_{\text{os}} = 120 \cdot \text{ft}^2 + (.6 \cdot \text{ft}^2 \cdot N_T)$ $A_{\text{os}} = 146.4 \cdot \text{ft}^2$

Volume for ship support: $V_{\text{SS}} = V_{\text{aux}} + 1.12 \cdot 7 \cdot \text{ft} \cdot 1.08 \cdot (A_{\text{bm}} + A_{\text{sr}} + A_{\text{os}})$

$$V_{\text{SS}} = 1.364 \cdot 10^4 \cdot \text{ft}^3$$

Pressure Hull:

$$V_{\text{PH}} := \frac{9.3 \cdot \text{ft}^3 \cdot N_T + (A_{\text{bm}} + A_{\text{sr}} + A_{\text{os}}) \cdot 7 \cdot \text{ft} \cdot (1.08 \cdot 1.12) + V_{\text{MOB}} + V_{\text{WEAPS}} + V_{\text{C3I}}}{.97}$$

$$V_{\text{PH}} = 5.913 \cdot 10^4 \cdot \text{ft}^3$$

OUTBOARD: $V_{ob} := .23 \cdot V_{PH}$ $V_{ob} = 1.36 \cdot 10^4 \cdot \text{ft}^3$

EVERBUOYANT VOLUME: $V_{eb} := V_{PH} + V_{ob}$ $V_{eb} = 7.273 \cdot 10^4 \cdot \text{ft}^3$

$$\Delta_{ebr} := V_{eb} \cdot 64 \cdot \frac{\text{lb}}{\text{ft}^3} \quad \Delta_{ebr} = 2.078 \cdot 10^3 \cdot \text{ton}$$

BALLAST TANK VOLUME: $V_{bt} := .13 \cdot V_{eb}$ $V_{bt} = 9.455 \cdot 10^3 \cdot \text{ft}^3$

SUBMERGED VOLUME: $V_s := V_{eb} + V_{bt}$ $V_s = 8.219 \cdot 10^4 \cdot \text{ft}^3$

$$\Delta_{sr} := V_s \cdot 64 \cdot \frac{\text{lb}}{\text{ft}^3} \quad \Delta_{sr} = 2.348 \cdot 10^3 \cdot \text{ton}$$

FREEFLOOD VOLUME: $V_{ff} := .06 \cdot V_{eb}$ $V_{ff} = 4.364 \cdot 10^3 \cdot \text{ft}^3$

ENVELOPE VOLUME: $V_{env} = V_s + V_{ff}$ $V_{env} = 8.655 \cdot 10^4 \cdot \text{ft}^3$

$$\Delta_{envr} = V_{env} \cdot 64 \cdot \frac{\text{lb}}{\text{ft}^3} \quad \Delta_{envr} = 2.473 \cdot 10^3 \cdot \text{ton}$$

III. VOLUME AVAILABLE

Using the formulae developed by CAPT Jackson the volume requirements calculated in Section II above and Figures 4 & 5, select L, D, and length of parallel mid-body and forward & aft shape factors. Also extract coefficients.

As a starting point use the following shape factors:

Entrance: $\eta_f = 2.5$ $C_{pf} = .75$ $C_{wsf} = .8452$ ##

Run: $\eta_a = 3$ $C_{pa} = .6429$ $C_{wsa} = .75$ ##

$$K1 = 6 - 2.4 \cdot C_{pf} - 3.6 \cdot C_{pa} \quad K1 = 1.886$$

Select L/D: $LOD := 7.6$

Select D: $D := 28 \cdot \text{ft}$ $L := LOD \cdot D$ $L = 212.8 \cdot \text{ft}$

$$\Delta_{enva} := \frac{\pi \cdot D^3}{4 \cdot 35} \cdot \frac{\text{ton}}{\text{ft}^3} \cdot (LOD - K1) \quad \Delta_{enva} = 2.815 \cdot 10^3 \cdot \text{ton}$$

$L_{PMB} := (LOD - 6) \cdot D$ $L_{PMB} = 44.8 \cdot \text{ft}$ $\Delta_{envr} = 2.473 \cdot 10^3 \cdot \text{ton}$ #ck

The tolerance for this volume balance is available volume must be greater than required volume - but by no more than 5%

$$\text{Err}_v := \frac{\Delta_{enva} - \Delta_{envr}}{\Delta_{envr}} \quad \text{Err}_v = 0.138$$

IV. WEIGHT ESTIMATION

$\Delta_{surf} := 2325 \cdot \text{tton}$ The following weight formula are taken from LT. Stennard's 1988 SM Thesis (Appendix I) #

$$W_{STR} := \left[\left(\Delta_{surf} \right) \cdot \left(.00055 \cdot \frac{D_D}{m} + .15 \right) \right] \quad \text{Input number of battery cells: } N_{cell} := 702$$

$$W_{STR} = 699.537 \cdot \text{tton}$$

$$W_{MOB} := \left(.596 \cdot N_{cell} + 2.0 \cdot \frac{SHP^{.64}}{hp^{.64}} \right) \cdot \text{tton} \quad W_{MOB} = 884.376 \cdot \text{tton}$$

$$W_{WEAPS} := \left(.002 \cdot \frac{V_{WEAPS}}{ft^3} + 6 \cdot TT + 5 \right) \cdot \text{tton} \quad W_{WEAPS} = 54.413 \cdot \text{tton}$$

$$W_{C3I} := .00836 \cdot \text{tton} \cdot \frac{V_{WEAPS}}{ft^3} \quad W_{C3I} = 56.065 \cdot \text{tton}$$

$$W_{FB} := .05 \cdot \Delta_{surf} \quad W_{SS} := .0336 \cdot \Delta_{surf} + N_T \cdot .4 \cdot \text{tton} \quad W_{VL} := .18 \cdot \Delta_{surf}$$

$$W_{VL} = 418.5 \cdot \text{tton}$$

Write in terms of Surfaced Displacement to get Weights yields the following expression for Submerged Displacement:

$$\Delta_{surf} \left(.00055 \cdot \frac{D_D}{m} + .15 \right) + \frac{W_{MOB}}{\text{tton}} + 54.413 + 56.065 + .05 \cdot \Delta_{surf} + (.0336 \cdot \Delta_{surf} + .4 \cdot N_T) + .18 \cdot \Delta_{surf}$$

$$k1 := \left(.00055 \cdot \frac{D_D}{m} + .15 \right) + .05 + .0336 + .18$$

$$k2 := \frac{W_{MOB}}{\text{tton}} + 54.413 + 56.065 + .4 \cdot N_T$$

$$\Delta_{surf} := \frac{k2}{1 - k1} \cdot \text{tton} \quad \Delta_{surf} = 2.325 \cdot 10^3 \cdot \text{tton}$$

V. OVERALL BALANCE:

This is the first opportunity to bring Weight and Volume calculations together. There are many different ways to compare the two, we will use everbuoyant volume (V_{eb}) and NSC (D_{surf}) weights. NOTE: All use of "volumes" in this section will be expressed in terms of tons.

$$\Delta_{eba} = \frac{\Delta_{enva}}{1.19}$$

$$\Delta_{eba} = 2.365 \cdot 10^3 \cdot \text{tton} \quad \Delta_{surf} = 2.325 \cdot 10^3 \cdot \text{tton}$$

$$Err := \frac{\Delta_{eba} - \Delta_{surf}}{\Delta_{eba}}$$

$$Err = 0.017$$

#ck

The tolerance at this point is $-.01 < Err < .05$. If out of tolerance, continue reading -

A. **WEIGHT LIMITED CASE ($V_{eb} < D_{surf}$)**: Due to the uncertainty in your design at this point, you do not have the luxury of shaving weight. Therefore you must add buoyancy. Return to Section III. and change shape factors, LOD (adding parallel mid-body) or D as appropriate for the magnitude of your imbalance.

B. **VOLUME LIMITED CASE ($V_{eb} > D_{surf}$)**: Due to the uncertainty in your design you do not have the luxury of "tightening up the design." At this point add lead (fixed ballast) you will have what is termed as a "lead mine."

C. **$V_{eb} = D_{surf}$** : After a couple iteration you should rewash this condition of designer's bliss. The next step is to determine wetted surface and confirm final envelope.

Wetted Surface:

$$K2 := 6 - 2.4 \cdot C_{wsf} - 3.6 \cdot C_{wsa} \quad K2 = 1.272$$

$$WS := \pi \cdot D^2 \cdot (LOD - K2) \quad WS = 1.559 \cdot 10^4 \cdot \text{ft}^2$$

Check wetted surface:

1. Entrance: $L_f := 2.4 \cdot D \quad L_f = 67.2 \cdot \text{ft} \quad x_f := 0, .11 .. 67.2$

$$L_{PMB} = 44.8 \cdot \text{ft}$$

$$y_f(x_f) = \left[1 - \left(\frac{x_f \cdot \text{ft}}{L_f} \right)^{\eta_f} \right]^{\frac{1}{\eta_f}} \cdot \frac{D}{2}$$

$$WS_f = \int_0^{L_f} y_f(x_f) \cdot 2 \cdot \pi \cdot \text{ft} \cdot dx_f \quad WS_f = 4.995 \cdot 10^3 \cdot \text{ft}^2$$

2. Run: $L_a := 3.6 \cdot D \quad L_a = 100.8 \cdot \text{ft} \quad x_a = 0, .11 .. 100.8$

$$y_a(x_a) = \left[1 - \left(\frac{x_a \cdot \text{ft}}{L_a} \right)^{\eta_a} \right]^{\frac{1}{\eta_a}} \cdot \frac{D}{2}$$

$$WS_a := \int_0^{L_a} y_a(x_a) \cdot 2 \cdot \pi \cdot \text{ft} \cdot dx_a \quad WS_a = 6.65 \cdot 10^3 \cdot \text{ft}^2$$

$$WS_{fa} := WS_f + WS_a \quad WS_{fa} = 1.165 \cdot 10^4 \cdot \text{ft}^2 \quad WS := WS_{fa} + \pi \cdot D \cdot L_{PMB} \quad \#ck$$

Final Envelope Displacement:

$$WS = 1.559 \cdot 10^4 \cdot \text{ft}^2$$

$$\Delta_e := \Delta_{enva}$$

$$\Delta_e = 2.815 \cdot 10^3 \cdot \text{tton}$$

This portion of the Math Model was deleted for brevity and does not affect the result.

**This portion of the Math Model was deleted for brevity
and does not affect the result.**

VIII. SPEED & POWER:

Section IX. provides a methodology consistent with that described on pages 1 -8 through 1 -10 of ref (a).

A. Effective Horsepower:

1. Resistance calculation parameters:

$$T_{SW} = 59 \quad \rho_{SW} = 1.9905 \cdot \text{lb} \cdot \frac{\text{sec}^2}{\text{ft}^4} \quad v_{SW} = 1.2817 \cdot 10^5 \cdot \frac{\text{ft}^2}{\text{sec}}$$

$$V = 0, .5, .30 \quad R_N(V) = L \cdot \frac{V \cdot 1.6889 \cdot \frac{\text{ft}}{\text{sec}}}{v_{SW}}$$

Wetted Surface (previously calculated): $WS = 1.559 \cdot 10^4 \cdot \text{ft}^2$

Correlation Allowance: $C_a = .0004$

2. Frictional resistance calculation: $C_f(V) = \frac{.075}{(\log(R_N(V)) - 2)^2}$

3. C_r calculation: using equation (11) from ref(a)- $C_r = \frac{.000789}{(LOD - K2)}$

4. Appendage drag (including sail) calculation:

a. From your arrangement drawing, enter surface area of the sail:

$A_s = 800 \cdot \text{ft}^2$ #

$C_{Ds} = .009$

$A_s \cdot C_{Ds} = 7.2 \cdot \text{ft}^2$

b. For the remaining appendages, use the expression on pg 15-9 for $A_A \cdot C_{dA}$:

$$App := \frac{L \cdot D}{1000} \quad App = 5.958 \cdot ft^2$$

5. Let's put it all together: we'll use equation (9) from ref(a)

$$EHP(V) = \frac{.00872 \cdot V^3 \cdot [WS \cdot (C_r + C_f(V) + C_a) + (A_s \cdot C_{Ds}) + App]}{ft^2}$$

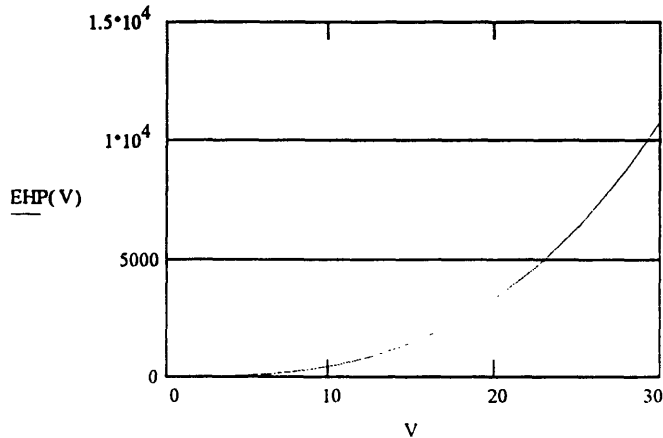

B. Shaft Horsepower:

1. Propeller Selection: Use series, ref (a) section 6, or other method to determine Propeller Open Water Efficiency- $\eta_o = .7$ #

2. Hull Efficiency: Use ref (a) Fig. 13- LOD - K2 = 6.328 $\eta_h = 1.24$ #

3. Relative Rotative efficiency: Assume- $\eta_{rr} := 1.03$ #

4. PC: $PC := \eta_o \cdot \eta_h \cdot \eta_{rr}$

5. SHP: $SHP(V) = \frac{EHP(V)}{PC}$

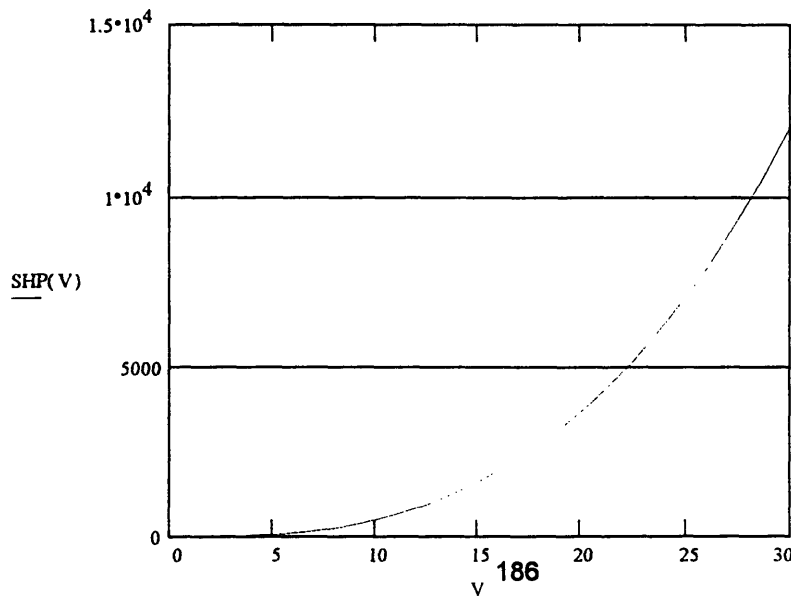

$$\text{SHP}(23) = 5.524 \cdot 10^3$$

C. Snorkeling Shaft Horsepower: Using Stenard's Appendix D method and assuming a 10 kt snort speed,

$$F_N := \frac{10 \cdot 1.6889 \cdot \text{ft}^5}{\sqrt{32.2 \cdot L}} \quad F_N = 0.204 \quad \text{SHP}(20) = 3.667 \cdot 10^3$$

$$C_w := \frac{0.9}{4 \cdot (\text{LOD} - 1.3606) \cdot \left(\frac{L}{D}\right)^2} \quad C_w = 6.243 \cdot 10^{-4}$$

$$\text{SHP}_w := .00872 \cdot 10^3 \cdot \text{WS} \cdot \frac{C_w}{\text{ft}^2}$$

$$\text{SHP}_{\text{sn}} := \text{SHP}_w + \text{SHP}(10) \quad \text{SHP}_{\text{sn}} = 567.205$$

D. Endurance Calculation: Using Stenard's Appendices E, P & M:

1. Specific Fuel Consumption (App P):

$$\text{SFC} = .55 \cdot \frac{\text{lb}}{\text{hp} \cdot \text{hr}}$$

2. Hotel Load: (Includes a correction for the differences in the results gained from Appendix M and Table 9-1.)

$$V_{\text{aux}} = .03 \cdot V_{\text{PH}} + 9.3 \cdot \text{ft}^3 \cdot N_T$$

$$V_{\text{SS}} = 1.12 \cdot 7 \cdot 1.08 \cdot (A_{\text{bm}} + A_{\text{sr}} + A_{\text{os}}) \cdot \text{ft} + V_{\text{aux}}$$

$$L_h = (1.5 \cdot V_{\text{MOB}} + 4 \cdot V_{\text{C3I}} + 1.5 \cdot V_{\text{SS}} + V_{\text{WEAPS}}) \cdot 10^{-3} \cdot \text{ft}^3$$

$$L_h = 98.595$$

The Battery Endurance at 4 knots is approximately:

$$\text{BattEND}_4 := 20.664 \cdot N_{\text{cell}} \cdot 0.9 \cdot 0.97 \cdot 0.90 \cdot \frac{1}{\frac{\text{SHP}(4)}{1.34} + L_h} \quad (\text{hours}) \quad \begin{array}{l} 0.97 = \text{Transmission } \eta \\ 0.90 = \text{Turndown } \eta \\ 0.90 = \text{Battery } \eta \end{array}$$

$$\text{BattEND}_4 = 92.353$$

The Battery Endurance at 20 knots is approximately:

$$\text{BattEND}_{25} := 20.664 \cdot N_{\text{cell}} \cdot 0.9 \cdot 0.97 \cdot \frac{1}{\frac{\text{SHP}(25)}{1.34} + L_h} \quad \text{BattEND}_{25} = 2.362$$

3. Bunker Fuel Requirements (App E):

$$E = 6.083 \cdot 10^7 \cdot \text{ft}$$

$$F := \frac{E \cdot \text{SFC} \cdot (1.09) \cdot (\text{SHP}_{\text{sn}} + 1.34 \cdot L_h) \cdot \text{hp}}{0.80 \cdot 10 \cdot \text{knt}} \quad F = 233.953 \cdot \text{ton} \quad \#$$

$$F_V := \frac{F}{62.4 \cdot \frac{\text{lb}}{\text{ft}^3} \cdot 0.85}$$

$$F_V = 9.88 \cdot 10^3 \cdot \text{ft}^3$$

$$\text{ig} = 0.16054 \cdot \text{ft}^3$$

$$\frac{F_V}{\text{ig}} = 6.154 \cdot 10^4 \quad (\text{imperial gallons})$$

4. Endurance at 8 knots snorting:

$$F_N := \frac{8 \cdot 1.6889 \cdot \text{ft}^5}{\sqrt{32.2 \cdot L}} \quad F_N = 0.163$$

$$C_w := \frac{0.5}{4 \cdot (\text{LOD} - 1.3606) \cdot \left(\frac{L}{D}\right)^2} \quad C_w = 3.468 \cdot 10^{-4}$$

$$\text{SHP}_w := .00872 \cdot 10^3 \cdot \text{WS} \cdot \frac{C_w}{\text{ft}^2}$$

$$\text{SHP}_{\text{sn}} := \text{SHP}_w + \text{SHP}(8) \quad \text{SHP}_{\text{sn}} = 298.423$$

$$\frac{F \cdot 0.80 \cdot 8 \cdot \text{knt}}{\text{SFC} \cdot (1.09) \cdot (\text{SHP}_{\text{sn}} + 1.34 \cdot L_h) \cdot \text{hp}} = 1.299 \cdot 10^4 \cdot \text{knt} \cdot \text{hr}$$

5. Endurance at 12 knots snorting:

$$F_N := \frac{12 \cdot 1.6889 \cdot \text{ft}^5}{\sqrt{32.2 \cdot L}} \quad F_N = 0.245$$

$$C_w := \frac{1.6}{4 \cdot (\text{LOD} - 1.3606) \cdot \left(\frac{L}{D}\right)^2} \quad C_w = 3.468 \cdot 10^{-4}$$

$$\text{SHP}_w := .00872 \cdot 10^3 \cdot \text{WS} \cdot \frac{C_w}{\text{ft}^2}$$

$$\text{SHP}_{\text{sn}} := \text{SHP}_w + \text{SHP}(12) \quad \text{SHP}_{\text{sn}} = 972.925$$

$$\frac{F \cdot 0.80 \cdot 12 \cdot \text{knt}}{\text{SFC} \cdot (1.09) \cdot (\text{SHP}_{\text{sn}} + 1.34 \cdot L_h) \cdot \text{hp}} = 7.594 \cdot 10^3 \cdot \text{knt} \cdot \text{hr}$$

Based on this fuel calculation and the results of part V and III new volume estimates are computed as follows:

$$V_{\text{PH}} = 5.913 \cdot 10^4 \cdot \text{ft}^3 \quad \text{the old figure}$$

is adjusted

$$V_{\text{PH}} = 5.913 \cdot 10^4 \cdot \text{ft}^3 \cdot (1.1473) \quad V_{\text{PH}} = 6.784 \cdot 10^4 \cdot \text{ft}^3$$

OUTBOARD: $V_{\text{ob}} = F \cdot V \cdot (.83) + 1280 \cdot \text{ft}^3 + .06 \cdot V_{\text{PH}} \quad V_{\text{ob}} = 1.355 \cdot 10^4 \cdot \text{ft}^3$

EVERBUOYANT VOLUME: $V_{\text{eb}} = V_{\text{PH}} + V_{\text{ob}} \quad V_{\text{eb}} = 8.139 \cdot 10^4 \cdot \text{ft}^3$

$$\frac{V_{\text{ob}}}{V_{\text{PH}}} = 0.2$$

$$\Delta_{\text{ebr}} := V_{\text{eb}} \cdot 64 \cdot \frac{\text{lb}}{\text{ft}^3} \quad \Delta_{\text{ebr}} = 2.325 \cdot 10^3 \cdot \text{ton}$$

$$\Delta_{\text{surf}} = 2.325 \cdot 10^3 \cdot \text{ton}$$

BALLAST TANK VOLUME: $V_{\text{bt}} = .15 \cdot V_{\text{eb}} \quad V_{\text{bt}} = 1.221 \cdot 10^4 \cdot \text{ft}^3$

SUBMERGED VOLUME: $V_s = V_{\text{eb}} + V_{\text{bt}} \quad V_s = 9.36 \cdot 10^4 \cdot \text{ft}^3$

$$\Delta_{\text{sr}} := V_s \cdot 64 \cdot \frac{\text{lb}}{\text{ft}^3} \quad \Delta_{\text{sr}} = 2.674 \cdot 10^3 \cdot \text{ton}$$

FREEFLOOD VOLUME: $V_{\text{ff}} = .06 \cdot V_{\text{eb}} \quad V_{\text{ff}} = 4.883 \cdot 10^3 \cdot \text{ft}^3 \quad \Delta_{\text{surf}} = 2.325 \cdot 10^3 \cdot \text{ton}$

ENVELOPE VOLUME: $V_{env} := V_s + V_{ff} \quad V_{env} = 9.848 \cdot 10^4 \cdot \text{ft}^3$

$$\Delta_{envr} := V_{env} \cdot 64 \cdot \frac{\text{lb}}{\text{ft}^3} \quad \Delta_{envr} = 2.814 \cdot 10^3 \cdot \text{ton}$$

$$\text{Err}_v := \frac{\Delta_{enva} - \Delta_{envr}}{\Delta_{envr}} \quad \text{Err}_v = 4.058 \cdot 10^{-4} \quad \text{ie, the new pressure hull volume agrees}$$

Now adjust the components of pressure hull volume so that their total matches our new figure:

$$V_{PH} = 6.784 \cdot 10^4 \cdot \text{ft}^3$$

Auxiliaries: $V_{aux} := .03 \cdot V_{PH} + 9.3 \cdot \text{ft}^3 \cdot N_T \quad V_{aux} = 2.444 \cdot 10^3 \cdot \text{ft}^3$

Berth & Mess: $A_{bm} := 10 \cdot \text{ft}^2 \cdot N_T \cdot (1.) \quad A_{bm} = 440 \cdot \text{ft}^2$

Storerooms: $A_{sr} = 8.5 \cdot \text{ft}^2 \cdot T_S \cdot (1.0) \quad A_{sr} = 765 \cdot \text{ft}^2$

Other Spaces: $A_{os} = 120 \cdot \text{ft}^2 + .6 \cdot \text{ft}^2 \cdot N_T \quad A_{os} = 146.4 \cdot \text{ft}^2$
(offices, etc)

Volume for ship support: $V_{SS} = V_{aux} - 1.12 \cdot 7 \cdot \text{ft} \cdot 1.08 \cdot (A_{bm} + A_{sr} + A_{os})$
 $V_{SS} = 1.389 \cdot 10^4 \cdot \text{ft}^3$

MOBILITY: $V_{MOB} = 5000 \cdot \text{hp} \cdot \rho_{MOB} \cdot (1.25) \quad V_{MOB} = 4.188 \cdot 10^4 \cdot \text{ft}^3$

WEAPONS: $V_{WEAPS} = (TT \cdot \rho_{TT} + RL \cdot \rho_{RL}) \cdot 1.0 \quad V_{WEAPS} = 6.706 \cdot 10^3 \cdot \text{ft}^3$

C^3 I: $V_{C3I} = 5300 \cdot \text{ft}^3 \cdot (1.0) \quad V_{C3I} = 5.3 \cdot 10^3 \cdot \text{ft}^3$

Now check to see if pressure hull volume OK: $V_{PH} = 6.784 \cdot 10^4 \cdot \text{ft}^3$

$$V_{PH} = \frac{9.3 \cdot \text{ft}^3 \cdot N_T + (A_{bm} + A_{sr} + A_{os}) \cdot 7 \cdot \text{ft} \cdot (1.08 \cdot 1.12) + V_{MOB} + V_{WEAPS} + V_{C3I}}{.97}$$

$$\text{SHP}(4) = 33.255 \quad \text{SHP}(20) = 3.667 \cdot 10^3 \quad \text{SHP}(22) = 4.849 \cdot 10^3$$

$$\text{SHP}(10) = 482.35 \quad \text{SHP}(21) = 4.231 \cdot 10^3 \quad \text{SHP}(23) = 5.524 \cdot 10^3$$

$$V_{PH} = 6.777 \cdot 10^4 \cdot \text{ft}^3 \quad \text{BattEND}_4 = 92.353 \quad W_{STR} = 699.44 \cdot \text{ton}$$

$$V_{ob} = 1.355 \cdot 10^4 \cdot \text{ft}^3 \quad \text{BattEND}_{25} = 2.362 \quad W_{MOB} = 884.376 \cdot \text{ton}$$

$$V_{eb} = 8.139 \cdot 10^4 \cdot \text{ft}^3 \quad W_{WEAPS} = 54.413 \cdot \text{ton}$$

$$V_{bt} = 1.221 \cdot 10^4 \cdot \text{ft}^3 \quad W_{C3I} = 56.065 \cdot \text{ton}$$

$$V_s = 9.36 \cdot 10^4 \cdot \text{ft}^3 \quad W_{FB} = 116.234 \cdot \text{ton}$$

$$V_{ff} = 4.883 \cdot 10^3 \cdot \text{ft}^3 \quad W_{SS} = 78.117 \cdot \text{ton}$$

$$V_{env} = 9.848 \cdot 10^4 \cdot \text{ft}^3 \quad W_{VL} = 418.442 \cdot \text{ton}$$

$$\frac{V_{bt}}{V_{eb}} = 0.15$$

$$\frac{V_{ff}}{V_{eb}} = 0.06$$

$$\frac{V_{ob}}{V_{PH}} = 0.2$$

$$\frac{W_{VL}}{\Delta_{surf}} = 0.18$$

$$\frac{W_{FB}}{\Delta_{surf}} = 0.05$$

(Blank Reverse)

APPENDIX D

HULL ENVELOPE

The envelope is first developed as a pure teardrop shape with the forward body comprising 40 percent of the length and the after body comprising the remaining 60 percent. The forward body is formed by revolving an ellipse about its major axis and is described by the following equation:

$$Y_f = b \left[1 - \left(\frac{X_f}{L_f} \right)^{n_f} \right]^{1/n_f} \quad (D.1)$$

The after body is formed by revolving a line parallel to the directrix and is described by:

$$Y_a = b \left[1 - \left(\frac{X_a}{L} \right)^{n_a} \right] \quad (D.2)$$

The quantities Y_f and Y_a are the local radii of the respective body of revolution with X_a and X_f describing the local position of the radius along the body, Figure D.1. If parallel midbody is added to the envelope, then cylindrical section with a radius equal to the maximum radius of the fore and after body is inserted in-between.

The local radii represent the offsets for drawing the submarine hull and also determine the prismatic coefficient for the hull section. The prismatic coefficient (C_p) is a hull form parameter for fullness and is the ratio of the volume of the body of revolution divided by the volume of a right cylinder with the same maximum radius. For an optimum shape, the fore and after bodies will have

different values for C_p . C_p is used to determine the total hull volume by the following relation:

$$\text{Volume} = \frac{\pi D^2}{4} \left[3.6DC_{pa} + \left(\frac{L}{D} - 6 \right) D + 2.4DC_{pf} \right]$$

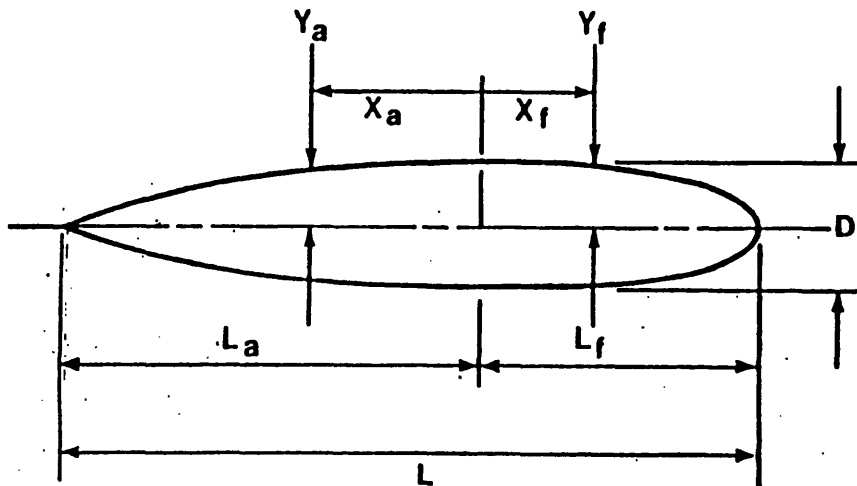

The Body of Revolution Hull

Figure D.1

where the added term $\left(\frac{L}{D} - 6\right)D$ accounts for the volume of the parallel midbody where $C_p = 1$.

Just as the volume of the envelope can be determined, the surface area for the body can be described by the following relation:

$$\text{Wetted Surface} = \pi D^2 \left[3.6DC_{sa} + \left(\frac{L}{D} - 6 \right) D + 2.4DC_{sf} \right]$$

Defined as the wetted surface, the surface area of the hull is a key determinant of the power required to drive the hull form through the water, and involves the surface coefficient (C_{sf}), which describes the ratio of the surface area of the body

of revolution to the surface area of a right cylinder with the same maximum radius.

The factors Π_f and Π_a in equations D.1 and D.2 describe the "fullness" of the body by affecting the curvature of the parabolas. Table D.1 lists some representative values for Π_f and Π_a along with their resultant C_p and C_{sf} . Figure D.2 illustrates the effect of varying Π_f and Π_a on the hull geometry.

Table D.1
Selected values for C_p and C_{sf} .

	Fore body				After body			
$\Pi_f (\Pi_a)$	2.0	2.5	3.0	3.5	2.0	2.5	3.0	3.5
C_p	.6667	.7493	.8056	.8443	.5333	.5954	.6429	.6808
C_{sf}	.7999	.8590	.8952	.9200	.6715	.7264	.7643	.7934

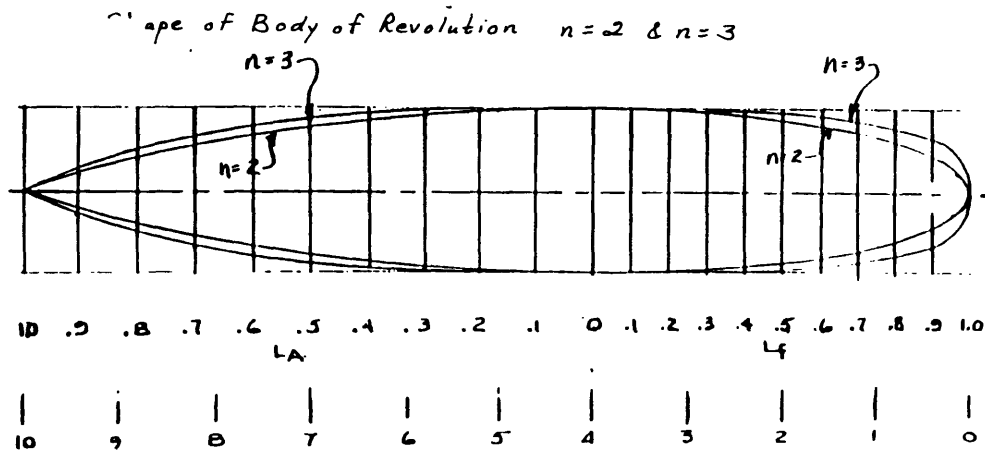

Effect of Π_f and Π_a on Hull Geometry

Figure D.2

The details of this appendix were derived from reference [33]

(Blank Reverse)

APPENDIX E

VOLUME DATA

E.0 OVERVIEW

This appendix contains the details of the volume estimates used in SUBSIZE. The volume data is based on the thesis by Stenard [61] which was further analyzed by Professor J. Reed for presentation in a special submarine design course at the Massachusetts Institute of Technology during the Independent Activities Period, January 1994. Table E.1 summarizes the volume data from Stenard. A discussion of the various factors chosen for the model follows:

E.1 FACTOR ANALYSIS

To build the submarine model, estimates of ship volumes must be made. Trends in this data must then be evaluated to develop parametrics from which predictions of submarine attributes can be made. These parametrics form the basis of the volume analysis below.

--- Mobility Volume

Reference [53] analysis of Stenard's data yields the parametric curve shown in Figure E.1. With an estimate of SHP for the baseline ship of 5000 SHP, a mobility density diesel electric (ρ_{DE}) of 6.7 ft³/SHP was selected. Because this density accounts only for the diesel electric plant, the additional volume for the AIP plant and any increased battery size from the baseline is added to determine the overall AIP volume of mobility.

$$V_{AIP} = SHP(\rho_{DE}) + \Delta V_{Battery} + V_{AIP}$$

Table E.1

Volume Data For Use in SUBSIZE

VOLUMES (ft³)

	KILO	WALRUS	BARBEL	2400	1700	2000	AVG
MOBILITY	33000	33527	25630	37044	50021	44000	37204
WEAPONS	10000	9281	7290	6724	5676	6000	7495
C³I	11000	5900	6701	9127	4806	5300	7139
SHIP SUPPORT	14000	27752	14562	11428	10043	10000	14631
VOL. ph	68000	76460	54183	64323	70546	65300	66469
O/B ITEMS	19500	9290	20895	11277	4354	6940	12043
VOL.eb	87500	85750	75078	75600	74900	72240	78511
MBT	24500	12250	11340	8400	7350	9310	12192
SUB. VOL	112000	98000	86418	84000	82250	81550	90703
FREEFLOOD	5600	4900	4618	4200	4112	4078	4585
ENVELOPE	117600	102900	91036	88200	86362	85628	95288

VOLUMES (EQUIVALENT DISPLACEMENTS ltons)

	KILO	WALRUS	BARBEL	2400	1700	2000	AVG
VOL. ph	1943	2185	1548	1838	2016	1866	1899
O/B ITEMS	557	265	597	322	124	198	344
VOL.eb	2500	2450	2145	2160	2140	2064	2243
MBT	700	350	324	240	210	266	348
SUB. VOL	3200	2800	2469	2400	2350	2330	2592
FREEFLOOD	160	140	132	120	117	117	131
ENVELOPE	3360	2940	2601	2520	2467	2447	2723

VOLUMES (% OF VOL ph)

	KILO	WALRUS	BARBEL	2400	1700	2000	AVG
MOBILITY	0.38	0.39	0.34	0.49	0.67	0.61	0.479
WEAPONS	0.11	0.11	0.10	0.09	0.08	0.08	0.095
C³I	0.13	0.07	0.09	0.12	0.06	0.07	0.090
SHIP SUPPORT	0.16	0.32	0.19	0.15	0.13	0.14	0.184
VOL. ph	0.78	0.89	0.72	0.85	0.94	0.90	0.848
O/B ITEMS	0.22	0.11	0.28	0.15	0.06	0.10	0.152
VOL.eb	1.00	1.00	1.00	1.00	1.00	1.00	1.000
MBT	0.28	0.14	0.15	0.11	0.10	0.13	0.152
SUB. VOL	1.28	1.14	1.15	1.11	1.10	1.13	1.152
FREEFLOOD	0.06	0.06	0.06	0.06	0.05	0.06	0.058
ENVELOPE	1.34	1.20	1.21	1.17	1.15	1.19	1.210

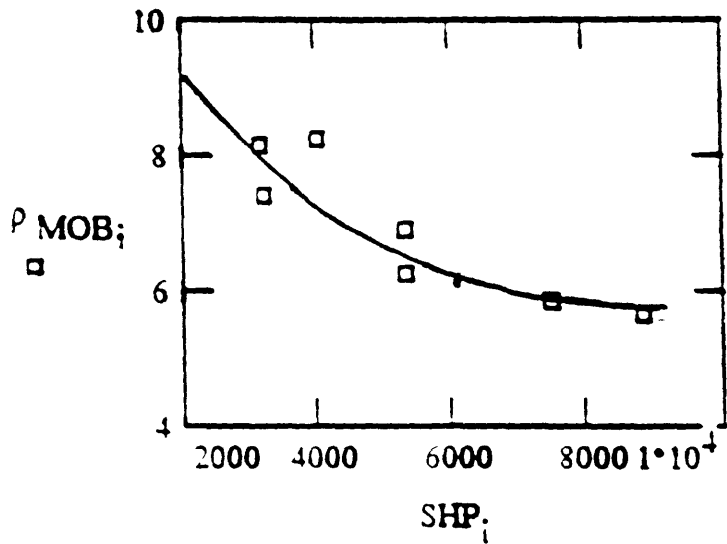

Mobility Density

Figure E.1

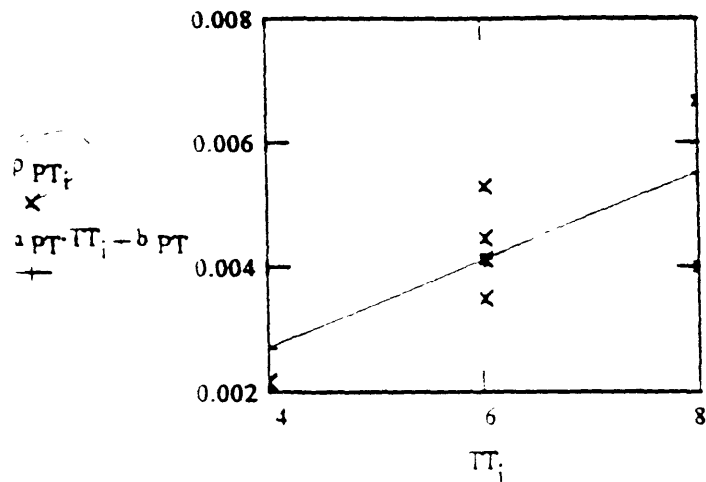
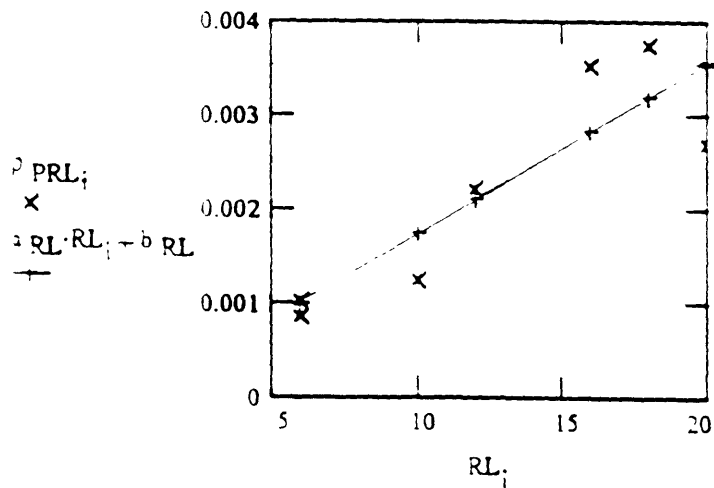

Torpedo Tube and Reload Densities

Figure E.2

--- Weapons

The weapons volume is based on similar parametric relationships for those weapons items that remain fixed in the ship, specifically the number of torpedo tubes installed and the room set aside for rack storage of weapons. Figure E.2 above presents the parametric curves for the torpedo tube (ρ_{TT}) and reload (ρ_{RL}) densities [53]. The densities are then multiplied against values set down in the owners requirements.

$$V_{weps} = \text{No. Torp. Tubes}(\rho_{TT}) + \text{No.Reloads}(\rho_{RL})$$

For this model values of 0.0042 and 0.0036 respectively were selected.

--- C³I Volume

The volume selected for C³I , 5300 ft³, was that of the British Type 2000 submarine based on the desire to have a ship with similar weapons and sensor capabilities.

--- Ship Support Volume

Four factors combine to provide input for this volume:

<u>Attribute</u>	<u>Factor</u>
Area Berthing and Messing (A_{bm})	10*crew size
Area Storeroom (A_{sr})	8.5*mission length
Area Office Spaces (A_{os})	120 + 0.6*crew size
Volume Auxiliaries (V_{aux})	a function of the above plus V_{ph}

These constants were selected based on design experience and requirements for habitability, adjusted for the fact that diesel submarines are generally not as spacious as nuclear powered ships. The areas above are converted to volumes by three multiplicative factors, 1.08 to account for added area for passageways, 1.12 to account for wasted space in the vicinity of the curved hull, and a standard deck height of 7 feet. The values are based on proven submarine designs.

--- Other Volumes

The volumes outside the pressure hull are also based on design experience and the data presented by Stenard. For SUBSIZE, the following factors were selected:

Outboard Margin (% V_{ph})	0.18
Volume Main Ballast Tanks (% V_{eb})	0.15
Volume Freeflood (% V_{eb})	0.06

(Blank Reverse)

APPENDIX F

WEIGHT DATA

F.0 OVERVIEW

This appendix contains the weight data base for SUBSIZE, Table F.1, as well as a discussion of the weight formulae presented by Stenard [61]. The weight data was further adjusted by Professor J. Reed for presentation in a special submarine design course presented at the Massachusetts Institute of Technology during the Independent Activities Period, January 1994.

F.1 FACTOR ANALYSIS

In his thesis, Stenard developed parametric equations for ship weights, based on the data in Table F.1. In general these equations were used with some modifications

--- Structural Weight

Stenard gives the following relation for structural weight:

$$W_{str} = \left\{ NSC \left[0.00055 (\text{Diving Depth } *) + 0.15 \right] \right\},$$

*in meters

which is a function of diving depth, sizing the pressure hull to withstand the pressure exerted by the sea. The formula was accepted with the factor 0.00055 changed to 0.00017 to allow the use of depth in feet.

--- Mobility Weight

Again Stenard gives a relationship which is accepted except that the battery weight for the baseline submarine, 420.96 ltons, is substituted for the battery weight factor

$$W_{mob} = 0.572(\# \text{ battery cells}) + 2.1(\text{SHP})^{0.64}.$$

**Table F.1
Weight Data For Use in SUBSIZE**

	KILO	WALRUS	BARBEL	2400	1700	2000	AVG
STRUCTURE	825	787	820	618	544	611	701
MOBILITY	700	792	575	868	988	922	808
WEAPONS	78	48	53	60	42	59	57
C ³ I	67	50	56	84	32	40	55
SHIP SUPPORT	101	98	117	101	67	76	93
A-1	1771	1775	1621	1731	1673	1708	1713
FIXED BALLAST	128	129	123	119	86	93	113
A	1899	1904	1744	1850	1759	1801	1826
VARIABLE LOAD	600	550	401	310	380	264	418
NSC	2499	2454	2145	2160	2139	2065	2244
MBT	700	350	324	240	210	266	348
SUB DISPL.	3199	2804	2469	2400	2349	2331	348

WEIGHTS (% OF A-1 tons)

	KILO	WALRUS	BARBEL	2400	1700	2000	AVG
STRUCTURE	0.47	0.44	0.51	0.36	0.33	0.36	0.409
MOBILITY	0.40	0.45	0.35	0.50	0.59	0.54	0.471
WEAPONS	0.04	0.03	0.03	0.03	0.03	0.03	0.033
C ³ I	0.04	0.03	0.03	0.05	0.02	0.02	0.032
SHIP SUPPORT	0.06	0.06	0.07	0.06	0.04	0.04	0.055
A-1	1.00	1.00	1.00	1.00	1.00	1.00	1.000
FIXED BALLAST	0.07	0.07	0.08	0.07	0.05	0.05	0.066
A	1.07	1.07	1.08	1.07	1.05	1.05	1.066
VARIABLE LOAD	0.34	0.31	0.25	0.18	0.23	0.15	0.243
NSC	1.41	1.38	1.32	1.25	1.28	1.21	1.309
MBT	0.40	0.20	0.20	0.14	0.13	0.16	0.202
SUB DISPL.	1.81	1.58	1.52	1.39	1.40	1.36	0.202

WEIGHTS (% OF NSC)

	KILO	WALRUS	BARBEL	2400	1700	2000	AVG
STRUCTURE	0.33	0.32	0.38	0.29	0.25	0.30	0.312
MOBILITY	0.28	0.32	0.27	0.40	0.46	0.45	0.364
WEAPONS	0.03	0.02	0.02	0.03	0.02	0.03	0.025
C ³ I	0.03	0.02	0.03	0.04	0.01	0.02	0.024
SHIP SUPPORT	0.04	0.04	0.05	0.05	0.03	0.04	0.042
A-1	0.71	0.72	0.76	0.80	0.78	0.83	0.766
FIXED BALLAST	0.05	0.05	0.06	0.06	0.04	0.05	0.050
A	0.76	0.78	0.81	0.86	0.82	0.87	0.817
VARIABLE LOAD	0.24	0.22	0.19	0.14	0.18	0.13	0.183
NSC	1.00	1.00	1.00	1.00	1.00	1.00	1.000
MBT	0.28	0.14	0.15	0.11	0.10	0.13	0.152
SUB DISPL.	1.28	1.14	1.15	1.11	1.10	1.13	0.152

C ³ I (wt C ³ I Vol WEPS)	0.0067	0.0054	0.0077	0.0125	0.0056	0.0067	0.0074
--	--------	--------	--------	--------	--------	--------	--------

As was the case for mobility volume, the overall mobility weight is further adjusted to account for AIP weight and the change in battery weight

$$W_{mob} = \text{Battery Weight} + 2.1(\text{SHP})^{0.64} + \Delta W_{\text{Battery}} + W_{\text{AIP}}.$$

--- Weapons Weight

The following formula for weapons weight, based on the number of torpedo tubes and a factor for the size of the weapons spaces is given and accepted:

$$W_{weps} = [0.002(V_{weps}) + 6(\text{No. Torp Tubes}) + 5]$$

--- C³I Weight

Here Stenard gives a formula based on the volume of the C³I space:

$$0.00836(\text{Volume C}^3\text{I})$$

For SUBSIZE, a more traditional approach, that being a weight for C³I based on NSC is taken, with the following factor taken developed from Stenard's data:

$$W_{C^3I} = 0.025(\text{NSC})$$

--- Ship Support Weight

Again the parametric relationship presented by Stenard is used:

$$W_{ss} = 0.0336(\text{NSC}) + 0.4(\text{Crew Size}).$$

--- Other Weights

The remaining weights that make up NSC are margins, based on historical trends. These values become real numbers in the later stages of design as detailed design is conducted and better estimates for these values are obtained. For SUBSIZE, an initial value of 0.05 was selected for the lead margin which is consistent with Table F.1. The value of variable load should total to be

about 0.18 of NSC, but as explained in Chapter 6, fuel is included in the variable load weight, thus variable load must now consider the impact of AIP. During the validation of the model, it was observed that selecting a value for variable load fraction equal to 0.05 would yield a final variable load fraction of about 0.18.

APPENDIX G

SNORKEL POWERING

G.0 OVERVIEW

Chapter 6 provided the required formula constants applied to the hydrodynamic powering equations, which are well established. This appendix focuses on the method used to determine the required snorkel power for the submarine

G.1 PROCEDURE

When operating near the surface but not broached, ship powering is still governed by the effects of a body of revolution hull moving through a fluid. However due to the body's proximity to the surface, the additional effects of making a disturbance on the free surface must be considered. As in surface ship powering relationships, this additional power is a function of the Froude Number for the ship, determined by:

$$F_N = \frac{1.69(\text{Speed in knots})}{\sqrt{32.2 \frac{\text{ft}}{\text{sec}^2} (\text{Length})}}$$

This value is then used to enter Figure G.1, along with a ratio (h/L) to obtain a chart number which is proportional to the wave making resistance of the hull. In the ratio, "L" represents the length of the body of revolution while "h" is distance from the center of the body of revolution to the surface of the fluid, which is also illustrated in Figure G.1 this chart number is then applied to the following relationship to obtain the wave resistance coefficient:

$$C_{\text{wave}} = \frac{\text{Chart No.}}{4\left(\frac{1}{D} - k2\right)\left(\frac{1}{D}\right)^2}$$

C_{wave} is then converted to SHP by the relation:

$$\text{SHP}_{\text{wave}} = 8.72(WS)(C_{\text{wave}}).$$

This additional SHP due to wave action is added directly to SHP due to the body of revolution.

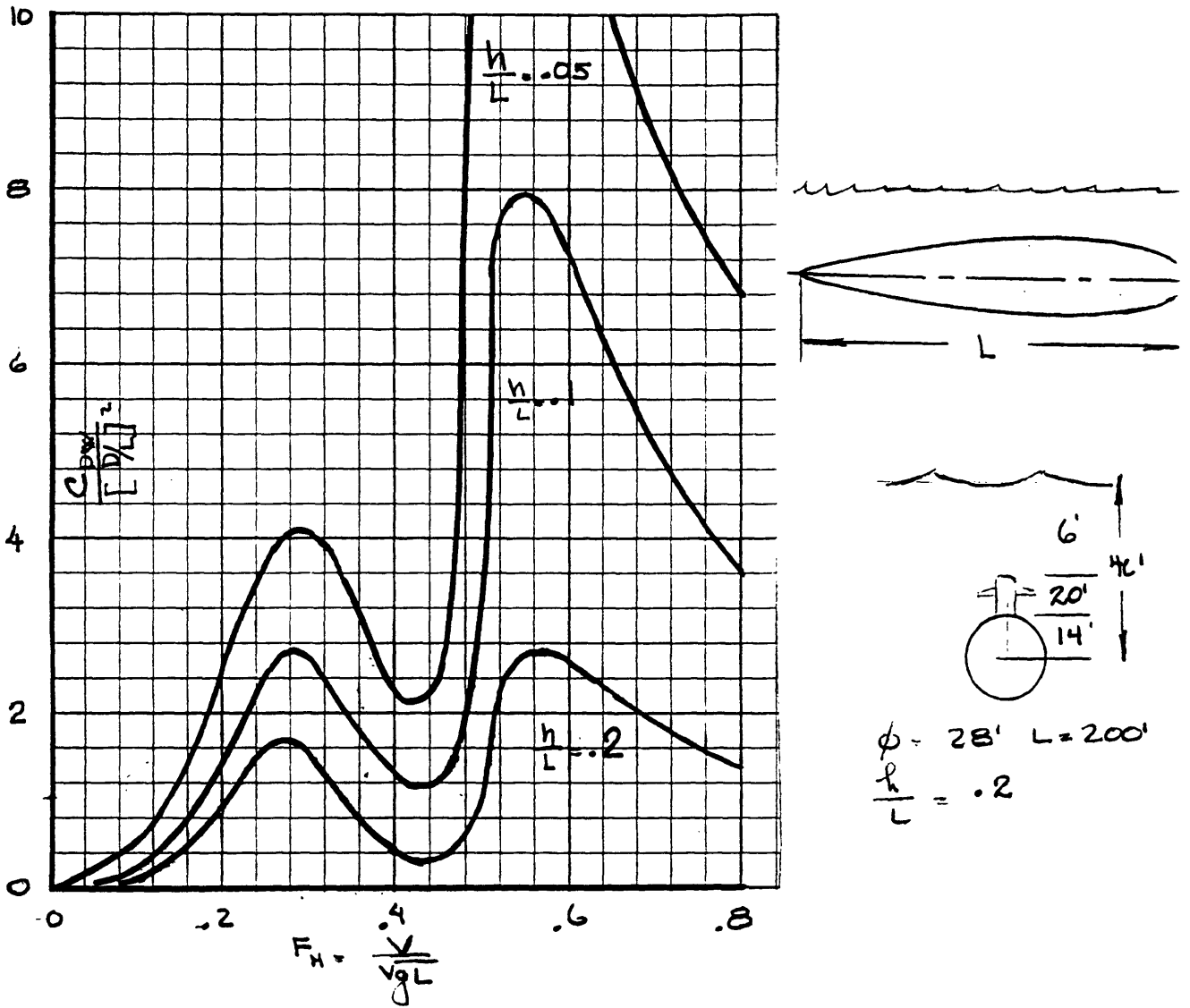

Wave Drag Coefficient

Figure G.1

APPENDIX H

DATA TABLES

This Appendix contains the data tables to support the results presented in Chapter 8.

Figure 8.1			
	NSC (ltons)	NSC (ltons)	% Differenc
BASELINE	2325	2316	0
PEM - 25 day endurance	3048	2804	-8
PEM - 35 day endurance	3207	3316	3
ALOX - 25 day endurance	3449	3430	-1
ALOX - 35 day endurance	3865	4544	18

Compare Plants at 25 day endurance

Figure 8.2

PLANT	LENGTH	LOD	NSC	SHP	AIP
ALOX	234.83	7.58	3142.14	4479.78	410.34
CBC	274.12	8.84	3842.31	5146.19	478.56
CCD	330.32	10.66	4845.22	6084.74	575.3
MCFC	201.35	6.5	2545.97	3903.28	351.69
PEM	202.35	6.53	2564.36	3920.66	353.45
STRLNG	327.71	1057	4798.36	6041.43	570.82

Figure 8.3			
PLANT	25 days	30 days	35 days
ALOX	3142.14	3727.37	4503.83
CBC	3842.31	5010.15	6740.92
CCD	4845.22	6817.33	10294.86
MCFC	2545.97	2949.08	3440.22
PEM	2564.36	2979.56	3518.17
STRLNG	4798.36	6724.82	10104.78

Figure 8.4				
	PEM			
	NSC	AIP Cap.	Ox Vol.	Ox Wt.
LOX	2564.36	353.45	10179.47	155.75
H2O2	2426.7	339.87	8136.44	102.58
NaClO3	2477.51	344.94	8853.96	139.5
GasOxEt	5582	645.97	32742.89	967
GasOxIn	19828.67	1967.46	299180.4	2945.24

Figure 8.5				
	PEM			
	NSC	AIP Cap.	Fuel Vol.	Fuel Wt.
METH	2564.36	353.45	3181.09	70.98
LIQ H2	4768.83	568.11	32723.23	236.22
HYDRIDE	11079.98	1163.5	18150.57	2199.01
GAS H2	19459.32	1933.76	209402.5	4385.76

Figures 8.6 and 8.7				
	PEM		PEM	
	NSC	Burst End.	NSC	Creep End.
Lead Acid	2564.36	2.94	2361.84	61.98
Ni/Cd	2587.94	4.6	2165.79	40.17
LAIS	2369.05	2.07	2366.25	87.14

Figure 8.8 (NSC)		
PLANT	FPP PC = .86	CR PC = .96
ALOX	3142.14	2769.17
CBC	3842.31	3231.83
CCD	4845.22	3989.18
MCFC	2545.97	2216.3
PEM	2564.36	2228.91
STRNG	4798.36	3956.16

Figure 8.9							
SPEED (kts)	DIAMETER (ft)	NSC (ltons)	LENGTH (ft)	L/D	HOTEL (kW)	SHP (hp)	AIP (kW)
8	30	5784.95	403.19	13.44	282.26	7077.37	671.99
8	31	5582	371.7	11.99	273.24	6766.44	645.97
8	32	5445.84	347.12	10.85	267.16	6535.07	627.25
8	33	5326.42	325.96	9.88	261.84	6334.32	610.95
8	34	5185.13	306.05	9.00	255.63	6130.29	593.52
8	35	5099.12	290.49	8.30	251.77	5984.13	581.64
8	36	5024.61	276.98	7.69	248.46	5858.67	571.42
8	37	4961.05	265.2	7.17	245.61	5751.01	562.63
8	38	4868.6	253.52	6.67	241.54	4868.6	551.88
8	39	4826.03	244.7	6.27	239.67	5556.75	545.91
8	40	4789.16	236.83	5.92	237.94	5492.17	540.57

Figure 8.10				
	NSC	AIP (kW)	AIP (ltons)	AIP (ft ³)
4	1877.63	135.69	109.39	9123.03
5	1910.88	158.6	127.14	10617.07
6	1994.7	195.44	155.69	13019.66
7	2216.63	257.56	203.82	17070.57
8	2564.36	353.45	278.12	23323.5
9	3127.89	506.55	396.74	33307.04
10	4002.03	753.71	588.23	49423.55

(Blank Reverse)

APPENDIX I

COMPUTER PROGRAM

I.0 OVERVIEW

This appendix contains the computer code, written in Turbo C++, using Borland Turbo C++ 3.0 and contains the following sections:

	<u>Section</u>	<u>Page No.</u>
I.1	Main Program - SUBSIZE.CPP	212
I.2	Header File - AIP.H	228
I.3	Powering Functions - POWERING.CPP	229
I.4	Printer File - PRINTER.CPP	233
I.5	AIP Sizing Functions and Plant Input Files - AIPSIZE.CPP	235
I.6	Sample Output	243

I.1 MAIN PROGRAM - SUBSIZE.CPP

//SUBSIZE

//This program determines the size of a
//concept hybrid AIP submarine

#include "aip.h"

char pause[1]; //To pause program at predetermned spots

//Ship parameters

float diving_depth = 900.0; //in ft
float max_shp = 5000.0; //initial installed shaft horsepower
float crew_size = 44.0;
float torpedo_tubes = 4.0;
float torpedo_reloads = 21.0;
float mission_length = 60.0; // in days
float max_speed = 20.0; // in knots
float burst_endurance = 2.0; // in hours
float snort_speed = 10.0; // in knots
float max_range = 10000.0; // nm total
float aip_speed = 8.0; // in knots
float aip_endurance = 25.0; // in days
float snort_range = max_range-(aip_endurance*aip_speed*24.0);
//determines snort range balance to acheive max range
float creep_speed = 4.0; // in knots
float recharge_speed = 4.0; //speed while recharging batteries
float transit_speed = 13.0; //speed while running on batteries
float creep_endurance = 90.0; // in hours
float pc = 0.863; // ratio EHP/SHP
float trans_eff = 0.96;

//Envelope

float sub_diameter = 31.0; // in ft^3
float pris_coef_fwd = 0.75; //determines forebody shape
float pris_coef_aft = 0.6429; //determines forebody shape
float wet_surf_coef_fwd = 0.8452; //deter. forebody wetted surface
float wet_surf_coef_aft = 0.75; //deter. afterbody wetted surface

```

//Margins and weights/volumes
float volume_c_cubed_i = 5300.0; // in ft^3
float fixed_ballast_margin = 0.05; //deter. initial lead margin
float variable_load_margin = 0.05; //estimate of variable load fraction
float c_cubed_i_factor = 0.025; //estimate of C^3I fraction of nsc
float mobility_density = 6.7; //in ft^3/hp
float torpedo_tube_density = 1/(.0042); //in ft^3/TT
float torpedo_reload_density = 1/(.0036); //in ft^3/reload
float outboard_margin = 0.18; //deter. otbd item vol.
float mbt_margin = 0.15; //deter. reserve buoyancy
float freeflood_margin = 0.06; //deter. freeflood vol.

```

```

//Battery
char battery_type[30] = "Lead Acid";
float batt_wt = 76.4; // in ltons
float batt_vol = 800.0; // in ft^3
float batt_two_hr_capacity = 1600.0; // in kW-hr
float batt_eighty_hr_capacity = 2645.5; // in kW-hr
float batt_cap_transit = 2455.6; //in kW-hrs
float num_batt_init = 5.51;
float coul_eff = 0.9; //effic. of extracting battery energy

```

```

//char battery_type[30] = " LAIS";
//float batt_wt = 3.69; // in ltons
//float batt_vol = 72.24; // in ft^3
//float batt_two_hr_capacity = 369.0; // in kW-hr
//float batt_eighty_hr_capacity = 858.0; // in kW-hr
//float batt_cap_transit = 0.0;
//float num_batt_init = 23.89;
//float coul_eff = 1.0; //effic. of extracting battery energy

```

```

//char battery_type[30] = " Ni/Cd";
//float batt_wt = 38.0; // in ltons
//float batt_vol = 670.0; // in ft^3
//float batt_two_hr_capacity = 1201.0; // in kW-hr
//float batt_eighty_hr_capacity = 1270.0; // in kW-hr
//float batt_cap_transit = 0.0;
//float num_batt_init = 10.78;
//float coul_eff = 0.9; //effic. of extracting battery energy

```

```

extern float batt_endur_burst, batt_endur_creep;
extern float num_batt;

```

```

float volume_weapons;           //in ft^3
float volume_mobility;          //in ft^3
float volume_aux;               //in ft^3
float volume_ship_support;      //in ft^3
float volume_pressure_hull;     //in ft^3
float volume_outboard;          //in ft^3
float volume_everbuoyant;       //in ft^3
float volume_main_ballast_tank; //in ft^3
float volume_submerged;         //in ft^3
float volume_freeflood;         //in ft^3
float volume_envelope_req;      //in ft^3

```

```

float weight_structure;         //ltons
float weight_mobility;          //ltons
float weight_c_cubed_i;         //ltons
float weight_weapons;           //ltons
float weight_fixed_ballast;     //ltons
float weight_ship_support;      //ltons
float weight_variable_load;     //ltons
float nsc;                       //ltons
float old_nsc;                   //ltons
float sub_length;                //feet
float speed;                      //knots
float wet_surf;                   //ft^2

```

//Declarations from aip header files:

```

float ehp_aip;
float shp_aip;
float reqd_capacity_aip;        // in kW
float plant_wt;
float plant_vol;
float reformer_wt;
float reformer_vol;
float oxidant_wt;
float oxidant_vol;
float fuel_wt;
float fuel_vol;
float other_wt;
float other_vol;
float product_wt;
float product_vol;
extern float lox_wt;
extern float lox_vol;

```

```

extern char plant_type[30];
extern char reformer[5];
extern char oxidant_type[30];
extern char fuel_type[30];
extern char other_type[30];
extern char product_mgmt[30];
extern char breathing_oxygen[5];

//Declarations from power()
float nu_sw = 1.2817/100000.0;
float reynolds_num;
float corr_allow = 0.0004;
float frict_coef;
float resid_coef;
float area_sail = 800.0;
float coef_drag_sail = 0.009;
float resist_bridge;
float resist_app;
extern float ehp, shp; //effective and shaft horsepower

//Declarations from hotel()
float hotel_load;

//Declarations from diesel()
float diesel_sfc = 0.55; // #/hp-hr
float diesel_mech_eta = 0.90;
float fuel_allow = 0.8; // % fuel use during mission
float bunker_fuel;

//Declarations from indesc()
float ehp_recharge;
float shp_recharge;
float time_recharge;
float batt_endur_transit;
float indesc_ratio;
float shp_transit;
float ehp_transit;
float soa;
float coef_wave;
float shp_wave;

```

```

#include <iostream.h>
#include <math.h>
#include <iomanip.h>
#include <fstream.h>
#include <string.h>

float pi = 4*atan(1.0);           //defines pi
float k1 = 6.0-3.6*pris_coef_aft //for hull shape calculations
        -2.4*pris_coef_fwd;
float k2 = 6.0-3.6*wet_surf_coef_aft //for wetted surf calculations
        -2.4*wet_surf_coef_fwd;

float aip_vol = 0.0;           //initially zero for baseline calc.
float aip_wt = 0.0;           //initially zero for baseline calc.
float delta_batt_wt = 0.0;     //initially zero for baseline calc.
float delta_batt_vol = 0.0;    //initially zero for baseline calc.

main()
{
cout << setiosflags(ios::fixed) <<setprecision(2);

        //Estimate required volume of the submarine with
        //volume function.

volume();

        //Determine envelope dimensions for a body of revolution
        //based on the estimated volume and curve factors.

envelope();

        //Estimate the required weight of the submarine with
        //weight function

weight();

        //This loop adds hull length if weight limited
        //and is skipped if volume limited.

wt_limit();

        //This loop adds lead weight if volume limited
        //and is skipped if weight limited.

vl_limit();

```



```

        //Determine the power required to push the body of revolution.

speed = max_speed;
power();
max_shp = shp;

        //Determine the propulsion power required while snorting
        //for the body of revolution.
snort();

        //Determine the hotel load for the ship.
hotel();

        //Determine diesel fuel required to transit the required snort distance.
diesfuel();

        //Determine battery size difference from the baseline.
battdelt();

        //Determine battery endurance.
battendr();

        //User select the AIP plant to evaluate.

int type;
cout << "\nSelect AIP type:\n";
cout << "PEM F C = 1\n";
cout << "Molten Carbonate F C = 2\n";
cout << "Al Ox Cell = 3\n";
cout << "Closed Diesel = 4\n";
cout << "Closed Brayton = 5\n";
cout << "Closed Stirling = 6\n";
cin>> type;
switch ( type )
{
    case 1: pemdecl(); break;
    case 2: mfcdecl(); break;
    case 3: aludecl(); break;
    case 4: ccddecl(); break;
    case 5: cbcdecl(); break;
    case 6: strdecl(); break;
    default:
        cout << "invalid entry should be integer between 1 and 6\n";
        break;
}

```

```

//Determine the size of the AIP plant.
aipsize();

//Now that the AIP plant has been sized,
//rerun weights and volumes.

do
{
old_nsc=nsc;

//Rerun volume estimate.
volume();

//Rerun envelope dimensions.
envelope();

//Rerun weight estimate.
weight();

//This loop grows the envelope volume if weight
//limited and is skipped if volume limited.

wt_limit();

//This loop adds lead weight if volume limited
//and is skipped if weight limited.

vl_limit();

//Determine the propulsion power required for
//a given speed for the body of revolution.

speed = max_speed;
power();
max_shp = shp;

//Determine the propulsion power required while
//snorting for the body of revolution.
snort();

//Determine the hotel load for the ship.
hotel();

//Determine diesel fuel required.
diesfuel();

```

```

        //Determine battery size difference from the baseline.
        battdelt();

        //Determine battery endurance.
        battendr();

        //Redetermine the AIP plant size.
        aipsize();

        //Determine indiscretion ratio parameters.
        indesc();

    }
while ((nsc-old_nsc)/nsc>0.01);

        //Prepare Screen Output

cout << "\t\t\t**** AIP SIZING PROGRAM OUTPUT****\n";
cout << "\t\t\t\t INPUT DATA\n";
cout << "\tRange: Total Ship Range (nm)\t\t\t"<<max_range<<"\n";
cout << "\t\tSnort @ "<<snort_speed<<" kts (nm)\t\t\t"
    <<snort_range<< "\n";
cout << "\t\tSubmerged @ "<<aip_speed<<" kts AIP (days)\t\t\t"
    <<aip_endurance<< "\n";
cout << "\t\tSubmerged creep @ "<<creep_speed
    <<" kts on battery (hours)\t"<<batt_endur_creep<< "\n";
cout << "\t\tSubmerged burst @ "<<max_speed
    <<" kts on battery (hours)\t"<<batt_endur_burst<< "\n";
cout << "\t\tSubmerged transit @ "<<transit_speed
    <<" kts on battery (hours)\t"<<batt_endur_transit<< "\n";
cout << "\t\tRecharge time @ "<<recharge_speed<<" kts (hours)\t\t\t"
    <<time_recharge<<"\n";
cout << "\t\tSOA (kts) "<<soa<< "\tIndiscretion Ratio\t"
    <<indesc_ratio<< "\n"<< "\n";
cout << "\tDiving Depth (ft):\t"<<diving_depth<<"\tCrew Size:\t"
    <<crew_size<< "\n";
cout << "\tTorpedo Tubes:\t\t"<<torpedo_tubes<<"\tReloads:\t"
    <<torpedo_reloads<< "\n";
cout << "\t\t\t\t MARGINS\n";
cout << "\tFixed Ballast (% NSC):\t\t"<<setprecision(3)
    <<fixed_ballast_margin<<setprecision(2)
    <<"\tVariable Load (% NSC):\t"<<variable_load_margin<< "\n";
cout << "\tOutboard Items (% Vph):\t\t"<<outboard_margin
    <<"\tRes. Buoyancy (% Veb):\t"<<mvt_margin<< "\n";
cout << "\tFreeflood Volume (% Veb):\t"<<freeflood_margin<< "\n";

```

```

cout << "\t\t\t\t ENVELOPE\n";
cout << "\tLength (ft):\t"<<sub_length<<"\t\tDiameter (ft):\t"
    <<sub_diameter<<"\tL/D:\t"<<sub_length/sub_diameter<< '\n';
cout << "\tCpf:\t"<<setprecision(4)<<pris_coef_fwd<<"\tCpa:\t"
    <<pris_coef_aft<<"\tCwsf:\t"<<wet_surf_coef_fwd<<"\tCwsa:\t"
    <<wet_surf_coef_aft<<setprecision(2)<< '\n';
//cin >>pause;

cout << "\t\t\t\t VOLUMES (ft^3)\n";
cout << "\tWeapons:\t"<<volume_weapons<<"\t\tMobility:\t\t"
    <<volume_mobility<< '\n';
cout << "\tShip Support:\t"<<volume_ship_support<< "\tC^3I:\t\t\t"
    <<volume_c_cubed_i<< '\n';
cout << "\tPressure Hull:\t"<<volume_pressure_hull<<"\tOutboard:\t\t"
    <<volume_outboard<< '\n';
cout << "\tEverbuoyant:\t"<<volume_everbuoyant
    <<"\tMain Ballast Tanks:\t"<<volume_main_ballast_tank<< '\n';
cout << "\tSubmerged:\t"<<volume_submerged<< "\tFreeflood:\t\t"
    <<volume_freeflood<< '\n';
cout << "\tEnvelope:\t"<<volume_envelope_req<< '\n';

cout << "\t\t\t\t WEIGHTS (ltons)\n";
cout << "\tStructure:\t"<<weight_structure<<"\t\tMobility:\t\t"
    <<weight_mobility<< '\n';
cout << "\tWeapons:\t"<<weight_weapons<< "\t\tC^3I:\t\t\t"
    <<weight_c_cubed_i<< '\n';
cout << "\tShip Support:\t"<<weight_ship_support
    <<"\t\tFixed Ballast:\t\t"<<weight_fixed_ballast<< '\n';
cout << "\t#Variable Load:\t"<<weight_variable_load
    <<"\t\tNormal Surf. Condition:\t"<<nsc<< '\n';

cout << "\t\t\t\t MOBILITY\n";
cout << "\tBattery Type:\t"<<battery_type<<"\tNumber of Batteries\t"
    <<num_batt<< '\n';
cout << "\tBattery: Weight(lton):\t"<<num_batt*batt_wt
    <<"\tVolume(ft^3):\t\t"<<num_batt*batt_vol<< '\n';
cout << "\tCapacity(kW-hr @ 2hr rate):\t"
    <<num_batt*batt_two_hr_capacity<< '\n';
cout << "\tPropulsive Coeff:\t"<<pc<<"\tInstalled SHP: \t\t"
    <<max_shp<< '\n';
cout << "\tHotel Load (kW):\t"<<hotel_load
    <<"\t#Bunker Fuel (ltons):\t"<<bunker_fuel<< '\n';
//cin >> pause;

```

```

cout << "\t\t\t\t AIP\n";
cout << "\tAIP Plant Size (kW):\t"<<reqd_capacity_aip<<\n';
cout << "\tType:\t\t"<<plant_type<<"\tWeight(ltons):\t"<<plant_wt
    <<"\tVolume(ft^3):"<<plant_vol<< \n';
cout << "\tReformer:\t"<<reformer<<"\tWeight(ltons):\t"<<reformer_wt
    <<"\tVolume(ft^3):"<<reformer_vol<< \n';
cout << "\tOxidant:\t"<<oxidant_type<<"\t#Weight(ltons):\t"
    <<oxidant_wt<<"\tVolume(ft^3):"<<oxidant_vol<< \n';
cout << "\tBreath. LOX:\t"<<breathing_oxygen<<"\t#Weight(ltons):\t"
    <<lox_wt<<"\tVolume(ft^3):"<<lox_vol<< \n';
cout << "\tFuel: \t"<<fuel_type<<"\t#Weight(ltons):\t"<<fuel_wt
    <<"\tVolume(ft^3):"<<fuel_vol<< \n';
cout << "\tOther: "<<other_type<<"\t#Weight(ltons):\t"<<other_wt
    <<"\tVolume(ft^3):"<<other_vol<< \n';
cout << "\tCosworth:\t"<<product_mgmt<<"\tWeight(ltons):\t"
    <<product_wt<<"\tVolume(ft^3):"<<product_vol<< \n';
cout << "\tTotals:\t\t\tWeight(ltons):\t"<<aip_wt
    <<"\tVolume(ft^3):"<<aip_vol<< \n';

```

```

//Send data to printer
#include "printer.cpp"

```

```

return 0;
}

```

```

//*****END OF MAIN PROGRAM SUBSIZE*****

```

```

//DIESFUEL

```

```

diesfuel()
{

```

```

//This subroutine calculates the amount of diesel fuel
//required to transit snort range at periscope depth.

```

```

extern float shp_snort;

```

```

bunker_fuel = (snort_range*diesel_sfc*(shp_snort+1.34*hotel_load))/
(2240.0*fuel_allow*trans_eff*snort_speed);

```

```

return (0);
}

```

```

/**END OF DIESFUEL0**

```

//ENVELOPE

```
envelope()
{
    //This function calculates a body of revolution length given
    //the envelope displacement and a diameter.

    sub_length = sub_diameter*(k1+((140.0*volume_envelope_req/35)
        /(pi*pow(sub_diameter,3))));

    return (0);
}

/**END OF ENVELOPE)**
```

//HOTEL

```
hotel()
{
    //This subroutine calculates hotel load based on
    //volume estimates.

    hotel_load = 15.0+(1.5*volume_mobility+4.0*volume_c_cubed_i+
        1.5*volume_ship_support+volume_weapons)/1000.0;

    return (0);
}

/**END OF HOTEL)**
```

```

                                //INDESC()
indesc()
{
    //This subroutine calculates the indiscretion ratio for an
    //assumed snort speed while recharging batteries

    //calculate the shp at recharge speed
    speed = recharge_speed;
    power();
    shp_recharge = shp;
    coef_wave = 0.2/(4.0*((sub_length/sub_diameter)-1.3606)*
                    pow(sub_length/sub_diameter,2));
                    //0.2 determined from Jackson notes pg. 6-23A
    shp_wave = 8.72*wet_surf*coef_wave;
    shp_recharge = shp_recharge+shp_wave;

    //calculate the hotel load during recharge
    hotel();

    //calculate time to recharge
    time_recharge = ((num_batt*batt_cap_transit)*0.80)/
                    ((3.0*990.0-shp_recharge*1.34+hotel_load)*0.80);

    //calculate endurance on battery at transit speed
    speed = transit_speed;
    power();
    shp_transit = shp;
    batt_endur_transit = (num_batt*batt_cap_transit-100.0)
                        *coul_eff*trans_eff/((shp_transit*0.746)+hotel_load);
                        //-100 accounts for 100 kW-hrs consumed while preparing
                        //for periscope depth operations.
                        //Calculate indiscretion ratio and speed of advance.

    indesc_ratio = time_recharge/(time_recharge+batt_endur_transit+1.0);
                    //+1.0 accounts for 1 hour of periscope depth preparation
                    //time with no distance travelled.

    soa = (time_recharge*recharge_speed+batt_endur_transit*transit_speed)/
          (time_recharge+batt_endur_transit+1.0);

    return(0);
}
                                /**END OF INDESC)**

```

```

//VOLUME()

volume()
{
    //This function calculates volumes for SUBSIZE.CPP

float volume_aux;                //in ft^3

volume_weapons = torpedo_tubes*torpedo_tube_density+
                torpedo_reloads*torpedo_reload_density;

volume_mobility = max_shp*mobility_density+aip_vol+delta_batt_vol;

    //volume_c_cubed_i is defined in subsize.cpp

float  area_berth_mess = 10*crew_size;                //in ft^2
float  area_storeroom = 8.5*mission_length;          //in ft^2
float  area_other_spaces = 120+(0.6*crew_size);      //in ft^2

    //volume_auxiliary is a function of volume pressure hull.

volume_pressure_hull = ((9.3*crew_size)
    +(area_berth_mess+area_storeroom+area_other_spaces)*7.0*1.08*1.12)
    +volume_mobility+volume_weapons+volume_c_cubed_i)/(0.97);

volume_aux = 0.03*volume_pressure_hull+9.3*crew_size;

volume_ship_support = volume_aux+1.12*7.0*1.08*(area_berth_mess+
    area_storeroom+area_other_spaces);

volume_outboard = outboard_margin*volume_pressure_hull;

volume_everbuoyant = volume_outboard+volume_pressure_hull;

volume_main_ballast_tank = mbt_margin*volume_everbuoyant;

volume_submerged = volume_main_ballast_tank+volume_everbuoyant;

volume_freeflood = freeflood_margin*volume_everbuoyant;

volume_envelope_req = volume_submerged+volume_freeflood;

return(0);
}

/**END OF VOLUME()**

```



```

//WEIGHT()
weight()
{
    //This subroutine calculates weights for SUBSIZE.CPP

    //weight_structure is a function of Normal Surfaced
    //Condition (nsc)

weight_mobility = 420.964+2.0*pow(max_shp, 0.64)
                +aip_wt+delta_batt_wt;

weight_weapons = 0.002*volume_weapons+6.0*torpedo_tubes+5;

    //weight_c_cubed_i is a function of nsc

    //weight_ship_support is a function of nsc

    //weight_fixed_ballast is a function of nsc

    //weight_variable_load is a function of nsc

nsc = (weight_mobility+weight_weapons+0.4*crew_size)/
      (1-((0.00016764*diving_depth+0.15)+0.0336
        +fixed_ballast_margin+c_cubed_i_factor
        +variable_load_margin)); //ltons

weight_structure = nsc*(0.00016764*diving_depth+0.15); //ltons
weight_ship_support = 0.0336*nsc+0.4*crew_size; //ltons
weight_fixed_ballast = fixed_ballast_margin*nsc; //ltons
weight_variable_load = variable_load_margin*nsc; //ltons
weight_c_cubed_i = c_cubed_i_factor*nsc; //ltons

return (0);
}

/**END OF WEIGHT()**

```

```

//VL_LIMIT
vl_limit()
{
    //This function balances weights and volumes if
    //volume limited.

    while (volume_everbuoyant/35>=nsc &&
           (volume_everbuoyant/35-nsc)/nsc>0.001)
    {

        while (volume_everbuoyant/35>=nsc &&
               (volume_everbuoyant/35-nsc)/nsc>0.001)
        {
            fixed_ballast_margin = fixed_ballast_margin + 0.0004;

            weight();
        }

    }
    return (0);
}

/**END OF VL_LIMIT**

```

```

//WT_LIMIT
wt_limit()
{
    //This subroutine balances weights and volumes if
    //weight limited.

    while (nsc>=volume_everbuoyant/35)
    {

        while (nsc>=volume_everbuoyant/35)
        {
            sub_length = sub_length+0.1;
            volume_envelope_req = ((pi*pow(sub_diameter,3))/4)
                *((sub_length/sub_diameter)-k1);

            volume_everbuoyant = volume_envelope_req
                /(1+mbt_margin+freeflood_margin);
        }

    }
}

```

```

//Recalculate the volumes that changed on matching
//weights and volumes.

volume_main_ballast_tank = mbt_margin*volume_everbuoyant;

volume_freeflood = freeflood_margin*volume_everbuoyant;

volume_submerged = volume_main_ballast_tank+
                    volume_everbuoyant;

volume_pressure_hull = volume_everbuoyant/
                      (1+outboard_margin);

volume_ship_support =volume_pressure_hull - volume_mobility
                    - volume_weapons-volume_c_cubed_i;

volume_outboard = volume_pressure_hull*outboard_margin;

    }
return (0);
}

/**END OF WT_LIMIT/**

```

I.2 HEADER FILE - AIP.H

```
//program aip.h  
//function prototypes
```

```
int volume();  
int envelope();  
int diesfuel();  
int hotel();  
int battendr();  
int battdel();  
int power();  
int aipsize();  
int weight();  
int wt_limit();  
int vl_limit();  
int snort();  
int aludecl();  
int cbcdecl();  
int ccddecl();  
int mfcdecl();  
int pemdecl();  
int strdecl();  
int indesc();
```

I.3 POWERING FUNCTIONS - POWERING.CPP

```
                                //POWERING.CPP

#include <math.h>
#include <fstream.h>
#include <string.h>
#include "aip.h"

float shp_batt_creep, ehp_batt_creep, batt_endur_creep;
float batt_endur_burst, ehp_batt_burst, shp_batt_burst;
float ehp,shp, num_batt;

extern float max_speed, speed, wet_surf, pi;
extern float sub_diameter, sub_length, k2, reynolds_num, nu_sw;
extern float frict_coef, resid_coef, resist_bridge, area_sail;
extern float coef_drag_sail, resist_app, corr_allow, pc, num_batt;
extern float num_batt_init, batt_two_hr_capacity;
extern float batt_eighty_hr_capacity, coul_eff, trans_eff;
extern float hotel_load, creep_speed, motor_eff, batt_endur_creep;
extern float creep_endurance, batt_wt, delta_batt_vol;
extern float delta_batt_wt, batt_vol, burst_endurance;
extern float coef_wave, shp_wave;
    //Declarations from snort:
float chart_number = 0.9; //obtained from Jackson notes pg. 6-23A
float shp_snort, ehp_snort;
extern float snort_speed;

                                //BATTDDELTO

battdelt()
{
    //This subroutine calculates the change in battery size
    //from a baseline diesel electric lead acid battery.

float reqd_capacity_burst;
float num_batt_burst;
float delta_batt_burst;
float reqd_capacity_creep;
float num_batt_creep;
float delta_batt_creep;
float delta_batt;
```

```

num_batt = num_batt_init;

    //Calculate battery delta based on burst speed
speed = max_speed;
power();

ehp_batt_burst = ehp;
shp_batt_burst = shp;

reqd_capacity_burst = burst_endurance*((shp_batt_burst*0.746)
    +hotel_load)/(coul_eff*trans_eff);

num_batt_burst = reqd_capacity_burst/batt_two_hr_capacity;

delta_batt_burst = num_batt_burst - num_batt;
    //Calculate battery delta based on creep speed
speed = creep_speed;
power();

ehp_batt_creep = ehp;
shp_batt_creep = shp;

reqd_capacity_creep = creep_endurance*((shp_batt_creep*0.746)
    +hotel_load)/(coul_eff*trans_eff);

num_batt_creep = reqd_capacity_creep/batt_eighty_hr_capacity;

delta_batt_creep = num_batt_creep - num_batt;

if (delta_batt_burst>delta_batt_creep)
    {
    delta_batt = delta_batt_burst;
    }
else
    {
    delta_batt = delta_batt_creep;
    }

num_batt = num_batt+delta_batt;
delta_batt_wt = delta_batt*batt_wt;
delta_batt_vol = delta_batt*batt_vol;

return (0);
}

    /**END OF BATTDELTA**

```

//BATTENDR()

```
battendr()
{
    //This subroutine calculates endurance on the
    //installed battery.

    //Calculate burst endurance.
    speed = max_speed;
    power();

    ehp_batt_burst = ehp;
    shp_batt_burst = shp;

    batt_endur_burst = num_batt*batt_two_hr_capacity*coul_eff*trans_eff/
        ((shp_batt_burst*0.746)+hotel_load);

    //Calculate creep endurance.
    speed = creep_speed;
    power();

    ehp_batt_creep = ehp;
    shp_batt_creep = shp;

    batt_endur_creep = num_batt*batt_eighty_hr_capacity*coul_eff
        *trans_eff/((shp_batt_creep*0.746)+hotel_load);

    return (0);
}

    /**END OF BATTENDR()**
```

//POWER()

```
power()
{
    //This subroutine calculates the propulsive power required
    //for a given hull.

    //User must designate what speed is to be used before calling
    //POWER() by the following sequence:
    //
    //                                speed = ???_speed;
    //                                power();
```

```

        //Assumed seawater properties:      Temperature 59 deg F.
        //                                  rho: 1.9905 #-sec^2/ft^4.
        //                                  nu: 1.2817e-5 ft^2/sec.

wet_surf = pi*pow(sub_diameter,2)*(sub_length/sub_diameter-k2);

reynolds_num = (sub_length*speed*1.6889)/nu_sw;
frict_coef = 0.075/pow((log10(reynolds_num)-2),2);
resid_coef = 0.000789/((sub_length/sub_diameter)-k2);
resist_bridge = area_sail*coef_drag_sail;
resist_app = sub_length*sub_diameter/1000.0;

ehp = 0.00872*pow(speed,3)
      *(wet_surf*(frict_coef+resid_coef+corr_allow)
      +resist_bridge+resist_app);

shp = ehp/pc;

return (0);
}

        /**END OF POWER()**

        //SNORT

snort()
{
        //This subroutine calculates the propulsive power
        //required while snorting for a given hull.

speed = snort_speed;
power();

ehp_snort = ehp;
shp_snort = shp;

coef_wave = chart_number/(4.0*((sub_length/sub_diameter)-1.3606)*
        pow(sub_length/sub_diameter,2));

shp_wave = 8.72*wet_surf*coef_wave;

shp_snort = shp_snort+shp_wave;

return(0);
}

        /**END OF SNORT()**

```

I.4 PRINTER FILE - PRINTER.CPP

```

ofstream prn("PRN");
prn << setiosflags(ios::fixed) <<setprecision(2);
prn << "\t\t\t****AIP SIZING PROGRAM OUTPUT****"<< '\r';
prn << "\t\t\t****AIP SIZING PROGRAM OUTPUT****\n\n";
prn << "\t\t\t\t INPUT DATA\t\t"<<plant_type<<'\n'<<'\n';
prn << "\tRange: Total Ship Range (nm)\t\t\t"<<max_range<<'\n';
prn << "\t\tSnort @ "<<snort_speed<<" kts (nm)\t\t\t"
    <<snort_range<< '\n';
prn << "\t\tSubmerged @ "<<aip_speed<<" kts AIP (days)\t\t"
    <<aip_endurance<< '\n';
prn << "\t\tSubmerged creep @ "<<creep_speed
    <<" kts on battery (hours)\t"<<batt_endur_creep<< '\n';
prn << "\t\tSubmerged burst @ "<<max_speed
    <<" kts on battery (hours)\t"<<batt_endur_burst<< '\n';
prn << "\t\tSubmerged transit @ "<<transit_speed
    <<" kts on battery (hours)\t"<<batt_endur_transit<< '\n';
prn << "\t\tRecharge time @ "<<recharge_speed<<" kts (hours)\t\t"
    <<time_recharge<<'\n';
prn << "\t\tSOA (kts)  "<<soa<< "\t\tIndescrption Ratio\t"
    <<indesc_ratio<< '\n'<< '\n';
prn << "\tDiving Depth (ft):\t"<<diving_depth<<"\t\tCrew Size:\t"
    <<crew_size<< '\n';
prn << "\tTorpedo Tubes:\t\t"<<torpedo_tubes<<"\t\tReloads:\t"
    <<torpedo_reloads<< '\n';
prn << "\tMission Length (days):\t\t"<<mission_length<< '\n'<< '\n';
prn << "\t\t\t\t MARGINS\n\n";
prn << "\tFixed Ballast (% NSC):\t\t"<<setprecision(3)
    <<fixed_ballast_margin<<setprecision(2)
    <<"\t\tVariable Load (% NSC):\t"<<variable_load_margin<< '\n';
prn << "\tOutboard Items (% Vph):\t\t"<<outboard_margin
    <<"\t\tRes. Buoyancy (% Veb):\t"<<mbt_margin<< '\n';
prn << "\tFreeflood Volume (% Veb):\t"<<freeflood_margin<< '\n'<< '\n';
prn << "\t\t\t\t ENVELOPE\n\n";
prn << "\tLength (ft):\t"<<sub_length<<"\t\tDiameter (ft):\t"
    <<sub_diameter<<"\t\tL/D:\t"<<sub_length/sub_diameter<< '\n';
prn << "\tCpf:\t"<<setprecision(4)<<pris_coef_fwd<<"\t\tCpa:\t"
    <<pris_coef_aft<<"\t\tCwsf:\t"<<wet_surf_coef_fwd<<"\t\tCwsa:\t"
    <<wet_surf_coef_aft<<setprecision(2)<< '\n'<< '\n';
prn << "\t\t\t\t VOLUMES (ft^3)\n\n";
prn << "\tWeapons:\t"<<volume_weapons<<"\t\tMobility:\t\t"
    <<volume_mobility<< '\n';
prn << "\tShip Support:\t"<<volume_ship_support<< "\t\tC^3I:\t\t"
    <<volume_c_cubed_i<< '\n';

```

```

prn << "\tPressure Hull:\t"<<volume_pressure_hull<<"\tOutboard:\t\t"
    <<volume_outboard<< '\n';
prn << "\tEverbuoyant:\t"<<volume_everbuoyant
    <<"\tMain Ballast Tanks:\t"<<volume_main_ballast_tank<< '\n';
prn << "\tSubmerged:\t"<<volume_submerged<< "\tFreeflood:\t\t"
    <<volume_freeflood<< '\n';
prn << "\tEnvelope:\t"<<volume_envelope_req<< '\n'<< '\n';
prn << "\t\t\t\t WEIGHTS (ltons)\n\n";
prn << "\tStructure:\t"<<weight_structure<<"\t\tMobility:\t\t"
    <<weight_mobility<< '\n';
prn << "\tWeapons:\t"<<weight_weapons<< "\t\tC^3I:\t\t\t"
    <<weight_c_cubed_i<< '\n';
prn << "\tShip Support:\t"<<weight_ship_support
    <<"\t\tFixed Ballast:\t\t"<<weight_fixed_ballast<< '\n';
prn << "\t#Variable Load:\t"<<weight_variable_load
    <<"\t\tNormal Surf. Condition:\t"<<nsc<< '\n'<< '\n';
prn << "\t\t\t\t MOBILITY\n\n";
prn << "\tBattery Type:\t"<<battery_type<<"\t\tNumber of Batteries
    \t"<<num_batt<<'\n';
prn << "\tBattery: Weight(lton):\t"<<num_batt*batt_wt
    <<"\t\tVolume(ft^3):\t\t"<<num_batt*batt_vol<< '\n';
prn << "\tCapacity(kW-hr @ 2hr rate):\t"
    <<num_batt*batt_two_hr_capacity<< '\n';
prn << "\tPropulsive Coeff:\t"<<pc<<"\t\tInstalled SHP: \t\t"
    <<max_shp<< '\n';
prn << "\tHotel Load (kW):\t"<<hotel_load<<"\t\t#Bunker Fuel (ltons):\t"
    <<bunker_fuel<< '\n'<< '\n';
prn << "\t\t\t\t AIP\n\n";
prn << "\tAIP Plant Size (kW):\t"<<reqd_capacity_aip<<'\n';
prn << "\tType:\t\t"<<plant_type<<"\t\tWeight(ltons):\t"<<plant_wt
    <<"\t\tVolume(ft^3):"<<plant_vol<< '\n';
prn << "\tReformer:\t"<<reformer<<"\t\tWeight(ltons):\t"<<reformer_wt
    <<"\t\tVolume(ft^3):"<<reformer_vol<< '\n';
prn << "\tOxidant:\t"<<oxidant_type<<"\t\t#Weight(ltons):\t"
    <<oxidant_wt<<"\t\tVolume(ft^3):"<<oxidant_vol<< '\n';
prn << "\tBreath: LOX:\t"<<breathing_oxygen<<"\t\t#Weight(ltons):\t"
    <<lox_wt<<"\t\tVolume(ft^3):"<<lox_vol<< '\n';
prn << "\tFuel: \t"<<fuel_type<<"\t\t#Weight(ltons):\t"<<fuel_wt
    <<"\t\tVolume(ft^3):"<<fuel_vol<< '\n';
prn << "\tOther: " <<other_type<<"\t\t#Weight(ltons):\t"<<other_wt
    <<"\t\tVolume(ft^3):"<<other_vol<< '\n';
prn << "\tCosworth:\t"<<product_mgmt<<"\t\tWeight(ltons):\t"
    <<product_wt<<"\t\tVolume(ft^3):"<<product_vol<< '\n'<< '\n';
prn << "\tTotals:\t\t\tWeight(ltons):\t"<<aip_wt
    <<"\t\tVolume(ft^3):"<<aip_vol<< '\n'<< '\n'<< '\n';

```

I.5 AIP SIZING FUNCTIONS AND PLANT INPUT FILES - AIPSIZE.CPP

```
                //AIPSIZ.CPP
#include <math.h>
#include <fstream.h>
#include <string.h>
#include "aip.h"
float lox_wt, lox_vol;
extern float hotel_load, trans_eff, motor_eff, plant_wt;
extern float reqd_capacity_aip, plant_vol, reformer_wt, reformer_vol;
extern float oxidant_wt, oxidant_vol, fuel_wt, fuel_vol, crew_size;
extern float mission_length, speed, aip_speed, ehp_aip, ehp, shp_aip;
extern float shp, aip_endurance, other_wt, other_vol, product_wt;
extern float aip_wt, aip_vol, product_vol;

char plant_type[30];
float plant_wt_factor, plant_vol_factor, plant_wt_packing_factor;
float plant_vol_packing_factor, reformer_wt_factor;

char reformer[5];
float reformer_vol_factor, reformer_wt_packing_factor;
float reformer_vol_packing_factor;

char oxidant_type[30];
float oxidant_wt_factor, oxidant_vol_factor;
float oxidant_wt_packing_factor, oxidant_vol_packing_factor;

char fuel_type[30];
float fuel_wt_factor, fuel_vol_factor, fuel_wt_packing_factor;
float fuel_vol_packing_factor;

char other_type[30];
float other_wt_factor, other_vol_factor;
float other_wt_packing_factor, other_vol_packing_factor;

char product_mgmt[30];
float product_wt_factor, product_vol_factor;
float product_wt_packing_factor, product_vol_packing_factor;

char breathing_oxygen[5];
float ox_use_rate, lox_density, lox_ullage, lox_safety_margin;
float lox_vol_packing_factor, lox_wt_packing_factor;
```

```

aipsize()      //AIPSIZE()
{
    //This function calculates the size of the AIP plant
    //as well as breathing oxygen.
    //calculate the required liquid oxygen for the mission.
    lox_vol = crew_size*mission_length*lox_safety_margin*ox_use_rate
        /lox_ullage;
    lox_wt = lox_vol*lox_density/2240.0;
    lox_vol = lox_vol*lox_vol_packing_factor;
    lox_wt = lox_wt*lox_wt_packing_factor;
    //Calculate AIP parameters based on AIP speed.
    speed = aip_speed;
    power();
    ehp_aip = ehp;    shp_aip = shp;
    reqd_capacity_aip = (shp_aip*0.746+hotel_load)/trans_eff;
    plant_wt = reqd_capacity_aip*plant_wt_factor*(2.205/2240.0)
        *plant_wt_packing_factor;
    plant_vol = reqd_capacity_aip*plant_vol_factor
        *plant_vol_packing_factor;
    reformer_wt = reqd_capacity_aip*reformer_wt_factor*(2.205/2240.0)
        *reformer_wt_packing_factor;
    reformer_vol = reqd_capacity_aip*reformer_vol_factor
        *reformer_vol_packing_factor;
    oxidant_wt = aip_endurance*24.0*reqd_capacity_aip*oxidant_wt_factor
        *(2.205/2240.0)*oxidant_wt_packing_factor;
    oxidant_vol = aip_endurance*24.0*reqd_capacity_aip*oxidant_vol_factor
        *oxidant_vol_packing_factor;
    fuel_wt = aip_endurance*24.0*reqd_capacity_aip*fuel_wt_factor
        *(2.205/2240.0)*fuel_wt_packing_factor;
    fuel_vol = aip_endurance*24.0*reqd_capacity_aip*fuel_vol_factor
        *fuel_vol_packing_factor;
    other_wt = aip_endurance*24.0*reqd_capacity_aip*other_wt_factor
        *(2.205/2240.0)*other_wt_packing_factor;
    other_vol = aip_endurance*24.0*reqd_capacity_aip*other_vol_factor
        *other_vol_packing_factor;
    product_wt = reqd_capacity_aip*product_wt_factor*(2.205/2240.0)
        *product_wt_packing_factor;
    product_vol = reqd_capacity_aip*product_vol_factor
        *product_vol_packing_factor;
    aip_wt = plant_wt+reformer_wt+oxidant_wt+fuel_wt+other_wt
        +product_wt+lox_wt;
    aip_vol = plant_vol+reformer_vol+oxidant_vol+fuel_vol+other_vol
        +product_vol+lox_vol;
    return (0);
}          /**END OF AIPSIZE()**

```

```

aludecl()    //ALUDECL()
{
    //This file contains the declarations for the Aluminum-Oxygen
    //AIP Plant
    strcpy(plant_type, "ALOX");
    plant_wt_factor = 55.33;           // in kg/kW
    plant_vol_factor = 3.5;           // in ft^3/kW
    plant_wt_packing_factor = 1.0;
    plant_vol_packing_factor = 1.0;
    strcpy (reformer, "NO");           // enter yes/no.
                                        //If no, enter 0.0 in factors
    reformer_wt_factor = 0.0;         // in kg/kW
    reformer_vol_factor = 0.0;        // in ft^3/kW
    reformer_wt_packing_factor = 1.0;
    reformer_vol_packing_factor = 1.0;
    strcpy (oxidant_type, "LOX");
    oxidant_wt_factor = 0.263;        // in kg/kW-hr
    oxidant_vol_factor = 0.008;       // in ft^3/kW-hr
    oxidant_wt_packing_factor = 1.46;
    oxidant_vol_packing_factor = 3.0;
    strcpy (fuel_type, "  ALUMINUM");
    fuel_wt_factor = 0.28;            // in kg/kW-hr
    fuel_vol_factor = 0.0;            // in ft^3/kW-hr
    fuel_wt_packing_factor = 1.0;
    fuel_vol_packing_factor = 1.0;
    strcpy (other_type, "  KOH/WATER");
    other_wt_factor = 0.898;          // in kg/kW-hr
    other_vol_factor = 0.0318;        // in ft^3/kW-hr
    other_wt_packing_factor = 1.33;
    other_vol_packing_factor = 2.3;
    strcpy (product_mgmt,"NO");
    product_wt_factor = 0.0;          // in kg/kW
    product_vol_factor = 0.0;         // in ft^3/kW
    product_wt_packing_factor = 1.0;
    product_vol_packing_factor = 1.0;
    strcpy (breathing_oxygen, "NO");  //enter yes if oxidant type not LOX.
    ox_use_rate = 0.03;               //ft^3/man-day
    lox_density = 71.23;              //#/ft^3
    lox_ullage = 0.95;
    lox_safety_margin = 1.1;
    lox_vol_packing_factor = 3.0;
    lox_wt_packing_factor = 1.46;
    return (0);
}
    /**END OF ALUDECL()**

```

```

cbcdecl()          //CBCDECL()
{
    //This file contains the declarations for the Closed Brayton Cycle
    //AIP Plant
    strcpy (plant_type, "CBC");
    plant_wt_factor = 4.0;          // in kg/kW
    plant_vol_factor = 0.151;      // in ft^3/kW
    plant_wt_packing_factor = 1.0;
    plant_vol_packing_factor = 1.0;
    strcpy (reformer, "NO");       // enter yes/no.
                                    //If no, enter 0.0 in factors
    reformer_wt_factor = 0.0;      // in kg/kW
    reformer_vol_factor = 0.0;     // in ft^3/kW
    reformer_wt_packing_factor = 1.0;
    reformer_vol_packing_factor = 1.0;
    strcpy (oxidant_type, "LOX");
    oxidant_wt_factor = 0.872;     // in kg/kW-hr
    oxidant_vol_factor = 0.027;    // in ft^3/kW-hr
    oxidant_wt_packing_factor = 1.46;
    oxidant_vol_packing_factor = 3.0;
    strcpy (fuel_type, "DIESEL");
    fuel_wt_factor = 0.195;        // in kg/kW-hr
    fuel_vol_factor = 0.008;       // in ft^3/kW-hr
    fuel_wt_packing_factor = 1.0;
    fuel_vol_packing_factor = 1.0;
    strcpy (other_type, "COMP WATER");
    other_wt_factor = 0.278;       // in kg/kW-hr
    other_vol_factor = 0.03;       // in ft^3/kW-hr
    other_wt_packing_factor = 1.0;
    other_vol_packing_factor = 2.3;
    strcpy (product_mgmt, "YES");
    product_wt_factor = 1.67;      // in kg/kW
    product_vol_factor = 2.354;    // in ft^3/kW
    product_wt_packing_factor = 1.0;
    product_vol_packing_factor = 1.0;
    strcpy (breathing_oxygen, "NO"); //enter yes if oxidant type not LOX.
    ox_use_rate = 0.03;           //ft^3/man-day
    lox_density = 71.23;         //#/ft^3
    lox_ullage = 0.95;
    lox_safety_margin = 1.1;
    lox_vol_packing_factor = 3.0;
    lox_wt_packing_factor = 1.46;
    return(0);
}

    /**END OF CBCDECL()**

```

```

ccddecl()          //CCDDECL()
{
    //This file contains the declarations for the Closed Cycle Diesel
    //AIP Plant
    strcpy (plant_type, "CCD");
    plant_wt_factor = 11.7;          // in kg/kW
    plant_vol_factor = 0.389;      // in ft^3/kW
    plant_wt_packing_factor = 1.0;
    plant_vol_packing_factor = 1.0;
    strcpy (reformer, "NO");        // enter yes/no.
                                    //If no, enter 0.0 in factors
    reformer_wt_factor = 0.0;       // in kg/kW
    reformer_vol_factor = 0.0;      // in ft^3/kW
    reformer_wt_packing_factor = 1.0;
    reformer_vol_packing_factor = 1.0;
    strcpy (oxidant_type, "LOX");
    oxidant_wt_factor = 0.988;      // in kg/kW-hr
    oxidant_vol_factor = 0.031;    // in ft^3/kW-hr
    oxidant_wt_packing_factor = 1.46;
    oxidant_vol_packing_factor = 3.0;
    strcpy (fuel_type, "    DIESEL");
    fuel_wt_factor = 0.247;         // in kg/kW-hr
    fuel_vol_factor = 0.011;       // in ft^3/kW-hr
    fuel_wt_packing_factor = 1.0;
    fuel_vol_packing_factor = 1.0;
    strcpy (other_type, "COMP WTR + ARGON");
    other_wt_factor = 0.413;        // in kg/kW-hr //Includes
    other_vol_factor = 0.0806;     // in ft^3/kW-hr //conversion of
    other_wt_packing_factor = 1.0; //STP argon to high press. storage.
    other_vol_packing_factor = 1.0;
    strcpy (product_mgmt, "YES");
    product_wt_factor = 1.67;       // in kg/kW
    product_vol_factor = 2.354;     // in ft^3/kW
    product_wt_packing_factor = 1.0;
    product_vol_packing_factor = 1.0;
    strcpy (breathing_oxygen, "NO"); //enter yes if oxidant type not LOX.
    ox_use_rate = 0.03;             //ft^3/man-day
    lox_density = 71.23;            //#/ft^3
    lox_ullage = 0.95;
    lox_safety_margin = 1.1;
    lox_vol_packing_factor = 3.0;
    lox_wt_packing_factor = 1.46;
    return(0);
}

    /**END OF CCDDECL()**

```

```

mfcdecl()          //MFCDEC()
{
    //This file contains the declarations for the Molten Carbonate
    //FC AIP Plant
    strcpy (plant_type, "MCFC");
    plant_wt_factor = 24.6;           // in kg/kW
    plant_vol_factor = 1.08;        // in ft^3/kW
    plant_wt_packing_factor = 1.0;
    plant_vol_packing_factor = 1.0;
    strcpy (reformer, "NO");        // enter yes/no.
                                    //If no, enter 0.0 in factors
    reformer_wt_factor = 0.0;       // in kg/kW
    reformer_vol_factor = 0.0;      // in ft^3/kW
    reformer_wt_packing_factor = 1.0;
    reformer_vol_packing_factor = 1.0;
    strcpy (oxidant_type, "LOX");
    oxidant_wt_factor = 0.554;      // in kg/kW-hr
    oxidant_vol_factor = 0.017;     // in ft^3/kW-hr
    oxidant_wt_packing_factor = 1.46;
    oxidant_vol_packing_factor = 3.0;
    strcpy (fuel_type, "DIESEL");
    fuel_wt_factor = 0.165;         // in kg/kW-hr
    fuel_vol_factor = 0.007;        // in ft^3/kW-hr
    fuel_wt_packing_factor = 1.0;
    fuel_vol_packing_factor = 1.0;
    strcpy (other_type, "COMP WATER");
    other_wt_factor = 0.177;        // in kg/kW-hr
    other_vol_factor = 0.0191;      // in ft^3/kW-hr
    other_wt_packing_factor = 1.0;
    other_vol_packing_factor = 2.3;
    strcpy (product_mgmt, "YES");
    product_wt_factor = 1.67;       // in kg/kW
    product_vol_factor = 2.354;     // in ft^3/kW
    product_wt_packing_factor = 1.0;
    product_vol_packing_factor = 1.0;
    strcpy (breathing_oxygen, "NO"); //enter yes if oxidant type not LOX.
    ox_use_rate = 0.03;            //ft^3/man-day
    lox_density = 71.23;           ##/ft^3
    lox_ullage = 0.95;
    lox_safety_margin = 1.1;
    lox_vol_packing_factor = 3.0;
    lox_wt_packing_factor = 1.46;
    return(0);
}

    /**END OF MFCDECL()**

```



```

pemdecl()          //PEMDECL()
{
    //This function contains the declarations for the PEM AIP Plant
strcpy(plant_type, "PEM");
plant_wt_factor = 18.0;           // in kg/kW
plant_vol_factor = 0.343;        // in ft^3/kW
plant_wt_packing_factor = 1.0;
plant_vol_packing_factor = 1.0;
strcpy(reformer, "YES");         // enter yes/no.
                                //If no, enter 0.0 in factors

reformer_wt_factor = 18.0;       // in kg/kW
reformer_vol_factor = 0.424;    // in ft^3/kW
reformer_wt_packing_factor = 1.0;
reformer_vol_packing_factor = 1.0;
strcpy(oxidant_type, "LOX");
oxidant_wt_factor = 0.511;      // in kg/kW-hr
oxidant_vol_factor = 0.016;    // in ft^3/kW-hr
oxidant_wt_packing_factor = 1.46;
oxidant_vol_packing_factor = 3.0;
strcpy(fuel_type, " METHANOL");
fuel_wt_factor = 0.34;          // in kg/kW-hr
fuel_vol_factor = 0.015;       // in ft^3/kW-hr
fuel_wt_packing_factor = 1.0;
fuel_vol_packing_factor = 1.0;
strcpy(other_type, "COMP WATER");
other_wt_factor = 0.163;        // in kg/kW-hr
other_vol_factor = 0.0176;     // in ft^3/kW-hr
other_wt_packing_factor = 1.0;
other_vol_packing_factor = 2.3;
strcpy(product_mgmt, "YES");
product_wt_factor = 1.67;      // in kg/kW
product_vol_factor = 2.354;    // in ft^3/kW
product_wt_packing_factor = 1.0;
product_vol_packing_factor = 1.0;
strcpy(breathing_oxygen, "NO"); //enter yes if oxidant type not LOX.
ox_use_rate = 0.03;           //ft^3/man-day
lox_density = 71.23;          //#/ft^3
lox_ullage = 0.95;
lox_safety_margin = 1.1;
lox_vol_packing_factor = 3.0;
lox_wt_packing_factor = 1.46;
return (0);
}

    /**END OF PEMDECL()**

```

```

strdecl()          //STRDECL.()
{
    //This file contains the declarations for the Stirling AIP Plant
    strcpy(plant_type, "STRLNG");
    plant_wt_factor = 11.54;          // in kg/kW
    plant_vol_factor = 0.487;        // in ft^3/kW
    plant_wt_packing_factor = 1.0;
    plant_vol_packing_factor = 1.5;
    strcpy(reformer, "NO");          // enter yes/no.
                                        //If no, enter 0.0 in factors

    reformer_wt_factor = 0.0;        // in kg/kW
    reformer_vol_factor = 0.0;       // in ft^3/kW
    reformer_wt_packing_factor = 1.0;
    reformer_vol_packing_factor = 1.0;
    strcpy(oxidant_type, "LOX");
    oxidant_wt_factor = 1.0;         // in kg/kW-hr
    oxidant_vol_factor = 0.031;     // in ft^3/kW-hr
    oxidant_wt_packing_factor = 1.46;
    oxidant_vol_packing_factor = 3.0;
    strcpy(fuel_type, "DIESEL");
    fuel_wt_factor = 0.26;           // in kg/kW-hr
    fuel_vol_factor = 0.011;        // in ft^3/kW-hr
    fuel_wt_packing_factor = 1.0;
    fuel_vol_packing_factor = 1.0;
    strcpy(other_type, "COMP WATER");
    other_wt_factor = 0.319;         // in kg/kW-hr
    other_vol_factor = 0.0345;      // in ft^3/kW-hr
    other_wt_packing_factor = 1.0;
    other_vol_packing_factor = 2.3;
    strcpy(product_mgmt, "YES");
    product_wt_factor = 1.67;        // in kg/kW
    product_vol_factor = 2.354;     // in ft^3/kW
    product_wt_packing_factor = 1.0;
    product_vol_packing_factor = 1.0;
    strcpy(breathing_oxygen, "NO"); //enter yes if oxidant type not LOX.
    ox_use_rate = 0.03;              //ft^3/man-day
    lox_density = 71.23;             //#/ft^3
    lox_ullage = 0.95;
    lox_safety_margin = 1.1;
    lox_vol;                          // in ft^3
    lox_vol_packing_factor = 3.0;
    lox_wt;                            // in ltons
    lox_wt_packing_factor = 1.46;
    return(0);
}

    /**END OF STRDECL)**

```

1.6 SAMPLE OUTPUT

****AIP SIZING PROGRAM OUTPUT****

INPUT DATA		PEM
Range:	Total Ship Range (nm)	10000
	Snort @ 10 kts (nm)	5200
	Submerged @ 8 kts AIP (days)	25
	Submerged creep @ 4 kts on battery (hours)	90
	Submerged burst @ 20 kts on battery (hours)	2.94
	Submerged transit @ 13 kts on battery (hours)	14.2
	Recharge time @ 4 kts (hours)	5.3
	SOA (kts) 10.04	Indecretion Ratio 0.26
Diving Depth (ft):	900	Crew Size: 44
Torpedo Tubes:	4	Reloads: 21
Mission Length (days):		60

MARGINS

Fixed Ballast (% NSC):	0.112	Variable Load (% NSC):	0.05
Outboard Items (% Vph):	0.18	Res. Buovancy (% Veb):	0.15
Freefloat Volume (% Veb):	0.06		

ENVELOPE

Length (ft):	202.35	Diameter (ft):	31	L/D:	6.53
Cpf: 0.75	Cpa: 0.6429	Cwsf: 0.8452	Cwsa:	0.75	

VOLUMES (ft^3)

Weapons:	6785.71	Mobility:	50061.13
Ship Support:	13923.36	C^3I:	5300
Pressure Hull:	76070.2	Outboard:	13692.64
Everbuoyant:	89762.84	Main Ballast Tanks:	13464.43
Submerged:	103227.27	Freefloat:	5385.77
Envelope:	108613.04		

WEIGHTS (ltons)

Structure:	771.56	Mobility:	1167.96
Weapons:	42.57	C^3I:	64.11
Ship Support:	103.76	Fixed Ballast:	286.18
#Variable Load:	128.22	Normal Surf. Condition:	2564.36

MOBILITY

Battery Type:	Lead Acid	Number of Batteries	6.52
Battery Weight (lton):	497.79	Volume (ft^3):	5212.43
Capacity (kW-hr @ 2hr rate):		10424.87	
Propulsive Coeff:	0.86	Installed SHP:	3920.66
Hotel Load (kW):	138.96	#Bunker Fuel (ltons):	140.18

AIP

AIP Plant Size (kW):	353.45		
Type:	PEM	Weight (ltons):	6.26
Reformer:	YES	Volume (ft^3):	121.23
Oxidant:	LOX	Weight (ltons):	6.26
Breath:	LOX: NO	Volume (ft^3):	149.86
Fuel:	METHANOL	#Weight (ltons):	155.75
Other:	COMP WATER	Volume (ft^3):	10179.47
Cosworth:	YES	#Weight (ltons):	4.26
		Volume (ft^3):	275.12
		#Weight (ltons):	70.98
		Volume (ft^3):	3181.09
		#Weight (ltons):	34.03
		Volume (ft^3):	8584.69
		Weight (ltons):	0.58
		Volume (ft^3):	832.03
Totals:		Weight (ltons):	278.12
		Volume (ft^3):	23323.5

(Reverse Blank)

510007